

GefenPRO®



1080P
PROGRESSIVE

2K

3GSDI to 3GSDI Scaler

GEF-3GSDI-2-3GSDIS
User Manual

www.gefenpro.com

ASKING FOR ASSISTANCE

Technical Support:

Telephone (818) 772-9100
(800) 545-6900
Fax (818) 772-9120

Technical Support Hours:

8:00 AM to 5:00 PM Monday through Friday, Pacific Time
For 24 / 7 support, see the back of the product for the support number

Write To:

Gefen, LLC.
c/o Customer Service
20600 Nordhoff St
Chatsworth, CA 91311

www.gefenpro.com
support@gefenpro.com

Notice

Gefen, LLC reserves the right to make changes in the hardware, packaging, and any accompanying documentation without prior written notice.

3GSDI to 3GSDI Scaler is a trademark of Gefen, LLC

HDMI, the HDMI logo, and High-Definition Multimedia Interface are trademarks or registered trademarks of HDMI Licensing in the United States and other countries.

© 2012 Gefen, LLC. All rights reserved.
All trademarks are the property of their respective owners.

CONTENTS

1	Introduction
2	Operation Notes
3	Features
4	Panel Layout
5	Panel Descriptions
6	IR Remote Layout and Description
7	IR Remote Control Installation
7	Installing the Battery
7	Setting the IR Channel
8	Connecting The 3GSDI To 3GSDI Scaler
8	Wiring Diagram
9	Menu System
9	General Menu
10	Patterns Menu
10	Output Menu
11	Input Menu
13	Picture Menu
15	Layout Menu
15	Aspect Menu
17	RS-232 Serial Control
18	RS-232 Commands
33	Supported Video and Graphics Formats
36	Rack Mount Safety Information
37	Mounting Plate Installation
38	Appendix A
38	Gamma LUT File Format
39	Specifications
40	Warranty

INTRODUCTION

Congratulations on your purchase of the 3GSDI to 3GSDI Scaler. Your complete satisfaction is very important to us.

GefenPRO

In the realm of video distribution, certain features are invaluable in a commercial or broadcast environment. Accommodations such as a build-in power supply and flat black rack-mount enclosures set GefenPRO apart from our traditional products. Complex distribution units allow for professional DVI, 3G-SDI, and HDMI signals to be routed and converted easily and seamlessly, while being backed up by a renowned and dependable technical support team. Gefen invites you to explore the GefenPRO product line and hopes that you find the solution that fits your needs.

The GefenPRO 3GSDI to 3GSDI Scaler

The GefenPRO 3GSDI-2-3GSDIS provides high-performance scaling - including adjustable cadence detection, frame rate conversion, detail enhancement, and advanced noise reduction.

It works with SDI, ED-SDI, HD-SDI, or 3G-SDI signals and supports resolutions up to 1080p Full HD and 2048 x 1080 (2K).

This product can be used as a standalone frame synchronizer without scaling if desired. When frame synchronization is required, the video output of one source (or a reference signal) can be used to Genlock another input source. Genlock Mode, as well as all features of this scaler, can be controlled through the built-in menu system using the IR Remote Control or via RS-232 control.

How It Works

Connect SDI source devices to the SDI inputs and connect downstream equipment to the SDI outputs. Convenient SDI loop-through output connectors and an RCA Coax (S/PDIF) audio output allow monitoring of SDI video and audio. An external Genlock source may also be connected.

Configuration may be done using the IR Remote and the On-Screen Display (OSD) menu, or via the RS-232 port. A USB port is also provided for future firmware upgrades.

OPERATION NOTES

READ THESE NOTES BEFORE INSTALLING OR OPERATING THE 3GSDI TO 3GSDI SCALER

- The built-in GUI (Graphical User Interface) or On-Screen Display (OSD) provides convenient operation of the Scaler. The supplied IR Remote control operates the OSD. See pages 9 - 16 for details on the OSD commands.
- The IR Remote Control unit's IR channel must be identical to that of the Scaler. See page 30 for details on configuring the IR Channel on the 3GSDI to 3GSDI Scaler.
- The 3GSDI to 3GSDI Scaler supports many input and output resolutions. For a complete list of supported formats, see pages 33 - 35.
- Supports SMPTE standards 259M, 292M, SMPTE 274M, SMPTE 296M, ITU-R BT.656 and ITU-R BT.601. Handles 3G-SDI SMPTE 425-A and 425-B / formats 1080p 50/59.94/60.
- Internal software (firmware) may be upgraded via the built-in Serial or USB ports. Note that software updates performed on the USB port will be quicker due to its higher data transfer rate.

FEATURES

Features:

- Digital audio output
- Adjustable cadence detection
- Advanced noise reduction and detail enhancement
- Frame-rate conversion
- Fully integrated sprite-based Menu System
- Built-in pattern generator with Color Bars and Hatch Pattern
- RS-232 Control
- IR Remote Control (included)
- Field-upgradeable firmware via USB port
- Rack-mountable (rack ears included)

Package Includes

- (1) GefenPRO 3GSDI to 3GSDI Scaler
- (1) IR Remote Control
- (1) AC Power Cord
- (1) Set of Rack Ears
- (1) Quick-Start Guide

PANEL LAYOUT

Front Panel

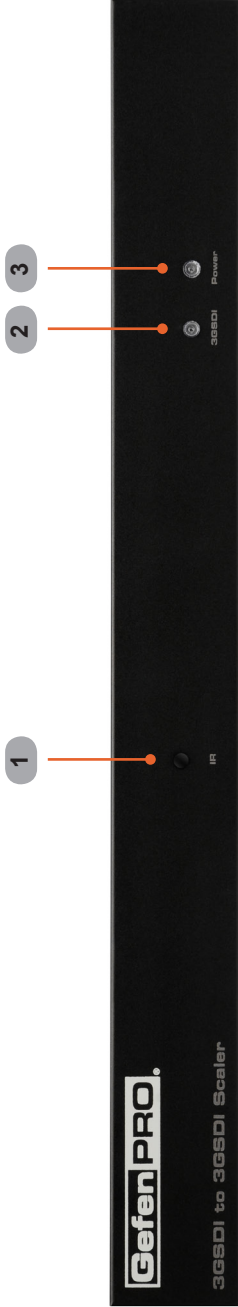

Back Panel

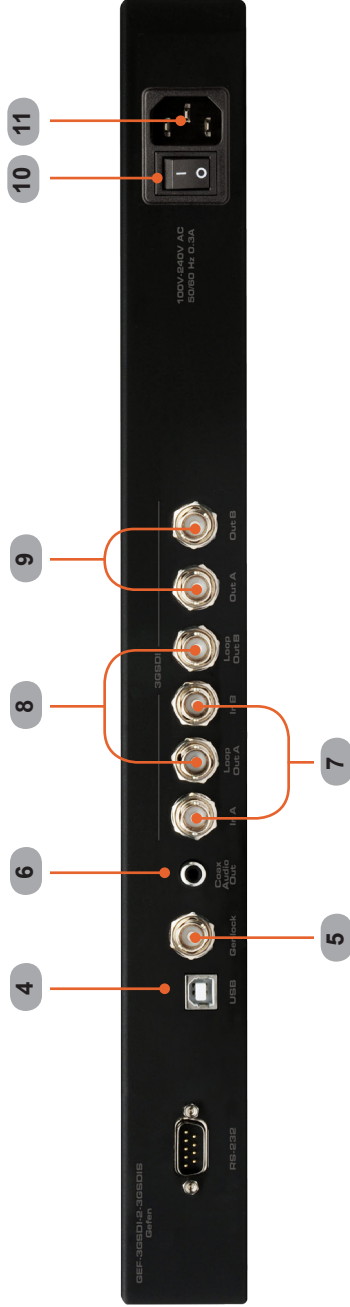

PANEL DESCRIPTIONS

- 1 IR**
Receives signals from the included IR Remote Control unit.
- 2 3GSDI**
This LED will glow bright blue when 3GSDI signals are detected on the input.
- 3 Power**
This LED will glow bright blue when the unit is powered.
- 4 USB**
Connect a USB cable from a computer to this USB port when updating the firmware.
- 5 Genlock**
Used to generator-lock (“genlock”) the video source with an external reference signal. Connect a BNC cable between the “genlock” device and the Genlock BNC connector.
- 6 Coax**
Connect a Coax cable from this S/PDIF connector to an audio output device.
- 7 In A, In B**
Connect BNC cables from the 3GSDI source to these connectors.
- 8 Loop Out A, Loop Out B**
Connect BNC cables from these connectors to a local SDI monitoring display. The Loop Out connectors pass-through the source signal without any processing.
- 9 Out A, Out B**
Connect BNC cables from these connectors to an SDI display.
- 10 Power Receptacle**
Connect the included AC power cord from this power receptacle to an available electrical outlet.
- 11 Power Switch**
Press this switch to power-on or power-off the scaler.

IR REMOTE LAYOUT AND DESCRIPTIONS

RMT-8HDS-IR

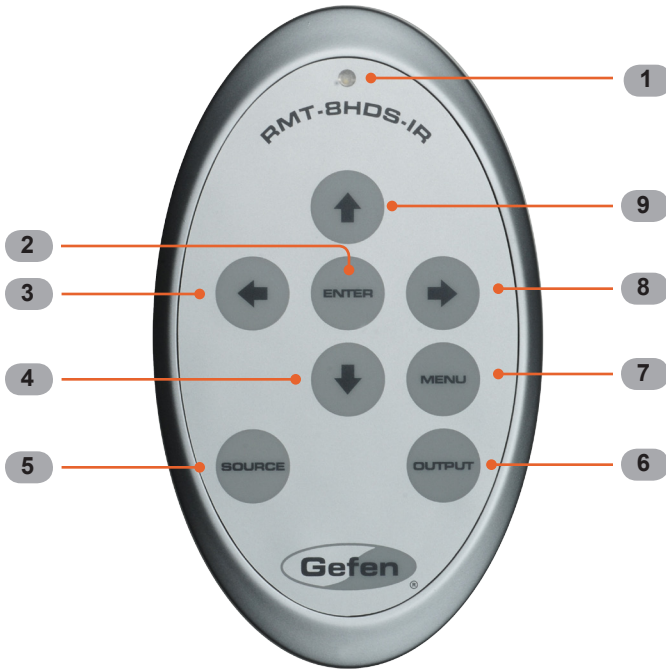

1. LED indicator - glows bright orange whenever a key is pressed, indicating the transmission of an IR command to the Scaler.
2. The ENTER button activates a selected menu option in the On-Screen Display.
3. LEFT direction key for menu navigation within the On-Screen Display.
4. DOWN direction key for menu navigation within the On-Screen Display.
5. Source - Cycles between available input sources. The selectable inputs are 3GSDI Input 1 and 3GSDI Input 2. Press once for Input 1; twice for Input 2.
6. Output - Cycles through the available output resolutions. See pages 33 - 35 for a list of output resolutions.
7. Menu - Displays the On-Screen Display menu system for control of the Scaler.
8. RIGHT direction key for menu navigation within the On-Screen Display.
9. UP direction key for menu navigation within the On-Screen Display.

IR REMOTE CONTROL INSTALLATION

Installing the Battery

The Remote Control unit ships with two batteries. One battery is required for operation and the other battery is a spare.

1. Remove the battery cover on the back of the IR Remote Control unit.
2. Insert the included battery into the open battery slot. The positive (+) side of the battery should be facing up.
3. Replace the battery cover.



NOTE: An Activity Indicator that flashes quickly while holding down any one of the 8 buttons indicates a low battery. Replace the IR Remote Control battery as soon as possible.



WARNING: Risk of explosion if battery is replaced by an incorrect type. Dispose of used batteries according to the instructions.

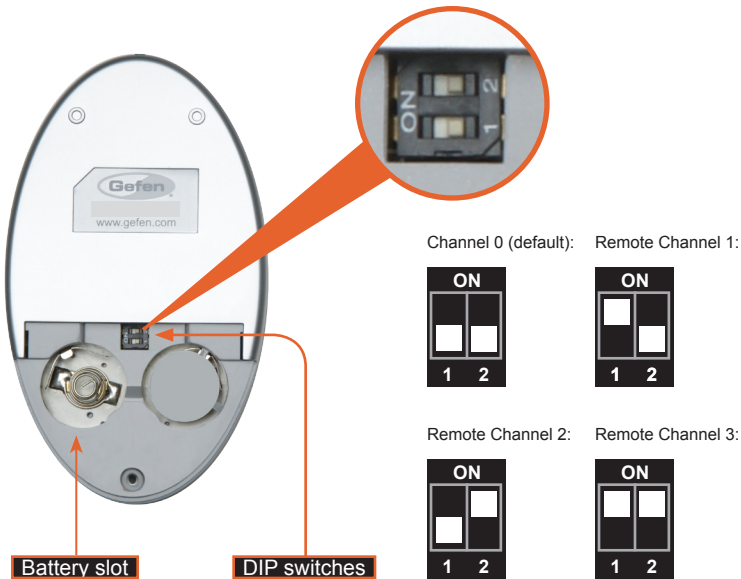

Setting the IR Channel

The IR channel on the IR Remote Control must match the IR channel used by the *3GSDI to 3GSDI Scaler*. For example, if both DIP switches on the IR Remote Control unit are set to IR channel 0 (both DIP switches down), then the *3GSDI to 3GSDI Scaler* must also be set to IR channel 0. See page 30 for information on how to change the IR channel on the *3GSDI to 3GSDI Scaler*.

CONNECTING THE 3GSDI TO 3GSDI SCALER

How to Connect the 3GSDI to 3GSDI Scaler

1. Connect a 3GSDI source to the In A connector on the 3GSDI to 3GSDI Scaler.
2. Connect the Out A port on the back of the Scaler to a 3GSDI display. The 3GSDI destination can be mirrored by connecting a BNC cable from the Out B port to a secondary 3GSDI display.



NOTE: In order to output dual link 1080p when using HD-SDI, both the Out A and Out B must be connected to the 3GSDI display.

3. Connect a coax cable from the S/PDIF output to an external amplifier.
4. If monitoring of the 3GSDI source is desired, connect a BNC cable from the Loop Out A connector to the 3GSDI display. The Loop Out connectors pass-through the source signal without any processing.
5. Connect the included AC power cord from the power receptacle to an available electrical outlet.
6. Power the 3GSDI to 3GSDI Scaler by pressing the power switch on the rear of the unit.

Wiring Diagram for the 3GSDI to 3GSDI Scaler

GefenPRO

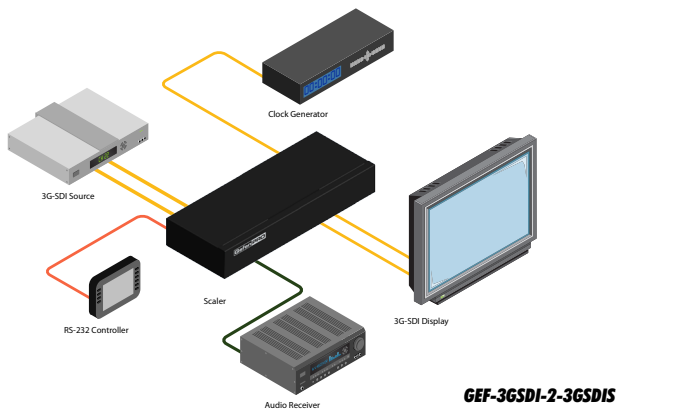

WARNING: This product should always be connected to a grounded electrical socket.

MENU SYSTEM

General Menu

Information

To access the General Menu, press the Menu button on the IR Remote Control Unit. The General Menu will be the first menu displayed on contains information about the Scaler:

- Host Firmware Version
- Kernel Version
- Configuration Version
- FPGA Version
- Remote Channel

General > Language

From the General Menu, press the ▼ button on the IR Remote Control Unit. Select the Language using the ► and ▼ buttons on the IR Remote Control Unit. Press the Menu button to exit the menu system.

- English
- French

General > Save Configuration

The Save Configuration feature is used to save the current configuration of the Scaler. Once the current configuration is saved, these settings will be restored each time the Scaler is powered.



WARNING: This function will overwrite any previously saved configuration, including the factory default settings. To restore the factory default settings, press the following buttons in order: Left, Right, and OK buttons. Do not depress all three buttons simultaneously.

General > Restore Default Configuration

Restores the Scaler to factory default settings. Use this feature to restore default configurations if they have been overwritten by using the **Save Configuration** function.

MENU SYSTEM

Patterns Menu

Patterns > Color Bars

Produces a color bar pattern, similar to a standard SMPTE bar pattern used for color calibration.

Patterns > Hatch Pattern

Produces a cross hatch pattern. This pattern can be used for “pin cushion” testing (curvature of the image on the screen) or color convergence / divergence.



NOTE: When a pattern is produced, the current video image will be masked.

Output Menu

The 3GSDI output signal can be configured from the Output menu. The Output menu controls several functions, such as resolution, link configuration (single link or dual link), genlock reference, and genlock offset.

Output > Output Format

Selects the output resolution. See pages 33 - 35 for details on available output formats.

Output > Link Configuration

Selects the link configuration in respect to color space. When using dual link SDI or HD-SDI input, YCbCr or RGB can be selected. If 3G-SDI is used, A or B (4:2:2 only) can be selected.

- Single Link YCbCr 4:2:2 (SD/HD/3G)
- Single Link 1080p (3G Level B)
- Dual Link YCbCr (HD)
- Dual Link RGB (HD)
- Dual Link 1080p / 576p / 480p (HD)

MENU SYSTEM

Output > Genlock Reference

This option enables or disabled the automatic genlock mode.

- Off
Disabled genlock
- Video Input
Uses the video input as the reference clock.
- Ref Input
Uses the clock attached to the Ref In connector on the back of the unit.

Output > Genlock Offset

This option provides the option to adjust the output lines and output pixels.

- Output Lines
- Output Pixels

Input Menu

Input > Input Video Format

Selects the resolution and timing of the input format. By default, this is set to Auto Detect which automatically senses the resolution and timing of the input signal. The available resolutions under this menu are in SD and HD format.

Input > Graphic Format

Selects the resolution and timing of the input format. By default, this is set to Auto Detect which automatically senses the resolution and timing of the input signal. The available resolutions under this menu are in VESA format.

Input > Clean Aperture

Allows adjustment of the input signal position. The clean aperture parameters allow an area within the production aperture to be defined. The minimum clean aperture size is 0 pixels by 0 lines.

- **Horizontal Size**
Adjusts the horizontal size of the image.
- **Vertical Size**
Adjusts the vertical size of the image.
- **Horizontal Position**
Adjusts the horizontal position of the image.
- **Vertical Position**
Adjusts the vertical position of the image.

Input > Film Mode

Automatically detects repeated field sequences present in interlaced signals, such as: 50 Hz or 60 Hz field sequences (no repeated fields), 60 Hz 3:2 pull-down, including broken / edited sequence detection, 60 Hz 2:2: pull-down, 50 Hz 2:2 pull-down, and Freeze frame.

- **Enable**
- **Disable**

Input > Remote Channel

This option changes the IR channel of the 3GSDI to 3GSDI Scaler to one of 4 different settings between 0 and 3. When the remote channel of the Scaler is changed, the DIP switches in the eight-button remote must be changed to the corresponding IR channel in order to operate the Scaler (see IR Remote Control Installation on page 7 for more information).

MENU SYSTEM

Input > Input Color Range

The RGB output color range may be changed/set to limited (16-235) or to full (0-255).

- **Auto**
Uses the color range of the input signal.
- **16 - 235 (Pass through)**
The input color range will be compressed from full-range (0 - 255) to limited-range.
- **0 - 255 (Compress)**
The output color range will be expanded from limited-range (16 - 235) to full-range (0 - 255).

Picture Menu

Picture > Image Color

Allows individual adjustment of the Red, Green, and Blue color components, brightness, and Black Level of the image.

- **Red**
Adjusts the saturation of the Red color component.
- **Green**
Adjusts the saturation of the Green color component.
- **Blue**
Adjusts the saturation of the Blue color component.
- **Brightness Red**
Adjusts the brightness of the Red color component.
- **Brightness Green**
Adjusts the brightness of the Green color component.
- **Brightness Blue**
Adjusts the brightness of the Blue color component.
- **RGB/Y Output Offset**
Adjusts the black level of the image.

Picture > Gamma Correction

- **Default**
Sets the default Gamma settings.
- **sRGB**
Gamma correction used with PCs, cameras, and printers.
- **User Table**
This option is used with a user Gamma LUT. See pages 38 for details on using a Gamma Look Up Table.
- **Custom Table**
Use when defining a custom LUT. See pages 38 for details on using a Gamma Look Up Table.
- **Gamma Coefficient**
Adjusts the Gamma coefficient in the range from 0.3 to 3.0. The default Gamma value is 1.0.



NOTE: When the Custom LUT (Look Up Table) is selected, the Gamma coefficient is used to calculate a new Gamma LUT.

Picture > Detail Enhancement

These parameters process the input data in either progressive or interlaced format. Changes to the detail enhancement are implemented at the start of the next frame of video. Both of these parameters can be adjusted within the range of 0 - 100.

- Detail Enhancement
- Noise Threshold

Picture > Noise Reduction

This is an adaptive noise reduction function which processes the input data in either progressive or interlaced format. Enabling the Noise Reduction on noisy interlaced signals can optimize de-interlacer performance.

Picture > Motion Threshold

This sets the intraframe motion detection threshold for the deinterlacer on the VXP processor. Video artifacts can be created when de-interlacing (creating interlaced fields from progressive fields). This function allows adjustment of the threshold used by the deinterlacer motion detection algorithm, removing / minimizing motion artifacts in the converted video.

MENU SYSTEM

Layout Menu

Layout > Size and Position

Set the size and the position of the image. Note that this option is not available in the panoramic aspect mode.

- **Horizontal Size**
Sets horizontal size of the output signal.
- **Vertical Size**
Sets vertical size of the output signal.
- **Horizontal Position**
Sets horizontal position of the output signal.
- **Vertical Position**
Sets vertical size of the output signal.

Aspect Menu

Aspect > Full Screen

Stretches the output signal to fill the display.

Aspect > Letter / Pillar Box

Sets the aspect ration to fit a letter or pillar box format.

Aspect > Panoramic

Sets the output signal to panoramic format.

Aspect > Extract

This function allows the Scaler to zoom in on a subset of the input video signal. This feature allows you to zoom on one selected section of the input picture.

- **Extract Size**
Selects the size of the subset to be extracted in percentage of the input.
- **Horizontal Position**
Moves the picture left or right (within the original input full size input).
- **Vertical Position**
Moves the picture up or down (within the original input full size input).

Aspect > Through

This function defines a sub-window that is always centered on the screen. The position is the relative position of the window within the full picture. This feature allows you to display one selected section of the input picture without modifying its size.

- **Horizontal Size**
Adjusts the size of the sub-window horizontally.
- **Vertical Size**
Adjusts the size of the sub-window vertically.
- **Horizontal Position**
Horizontally adjusts the relative position of the window within the full picture.
- **Vertical Position**
Vertically adjusts the relative position of the window within the full picture.



NOTE: When changing the input format, the Scaler will try and apply the current settings to the new input format. If this is not possible (e.g. the value is beyond the zoom limit), then the default value (100% size) will be used.

RS-232 SERIAL CONTROL

DE-9 Connector

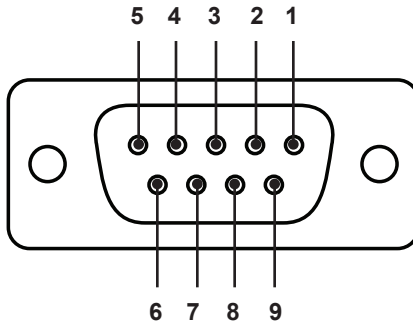

RS-232 Controller

Scaler

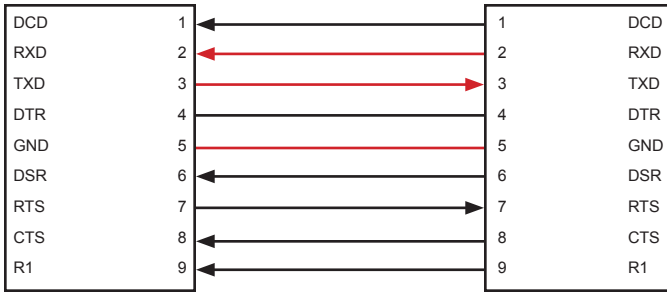

Only TXD, RXD, and GND are used.

RS232 Settings

Baud rate115200
 Data bits 8
 Parity bits None
 Stop bits 1
 Flow Control None



IMPORTANT: When sending RS-232 commands, a carriage return must be included at the end of the command. A space *must* be included between the command and the parameter.

RS-232 COMMANDS

Function	Description
<i>#aspect</i>	Sets the aspect ratio of the output signal
<i>#autolock</i>	Enables or disables the automatic genlock mode
<i>#blacklev</i>	Sets the black level (RGB/Y) of the output signal
<i>#bright</i>	Sets the brightness value for a specific color
<i>#cleanaper</i>	Sets the clean aperture level for position and size
<i>#contrast</i>	Sets the contrast level for a specific color
<i>#enhance</i>	Sets the enhancement value
<i>#extract</i>	Sets the extract aspect mode
<i>#filmmode</i>	Enables / disables film mode
<i>#gamma</i>	Sets the Gamma correction mode
<i>#help</i>	Lists all available commands
<i>#input</i>	Sets the input format of the image
<i>#key</i>	Execute the remote button actions as a string
<i>#language</i>	Sets the current language of the OSD
<i>#linkconfin</i>	Changes the input link configuration
<i>#linkconfout</i>	Changes the output link configuration
<i>#list</i>	Displays a list of all available commands on this Scaler
<i>#motionthres</i>	Sets the intraframe motion detection threshold
<i>#noisereduc</i>	Sets the noise reduction value
<i>#noisethres</i>	Sets the noise reduction threshold
<i>#output</i>	Sets the format (refresh rate) of the output signal
<i>#pattern</i>	Displays the specified test pattern
<i>#rb</i>	Resets the scaler
<i>#remotechan</i>	Sets the IR remote channel on the Scaler
<i>#restore</i>	Restores all the default parameters on the Scaler
<i>#save</i>	Saves the current parameters in memory
<i>#sizepos</i>	Sets the size and position of the image
<i>#through</i>	Sets the through aspect ratio
<i>#version</i>	Returns the version of the firmware and Kernel

RS-232 COMMANDS

#aspect Command

The `#aspect` command sets the aspect ratio of the output signal.

Syntax:

```
#aspect param1
```

Parameters:

param1

IR channel

[1 ... 5]

Value	Meaning
1	Full Screen
2	Letter / Pillar Box
3	Panoramic
4	Extract (Uses default value)
5	Through (Uses default Value)

Notes:

If the Extract or Through mode is selected, the default values are set. To modify the parameters for Extract or Through mode refer to these commands in this manual.

RS-232 COMMANDS

#autolock Command

The #autolock command enables / disables the Auto Genlock Mode. The

Syntax:

```
#autolock param1
```

Parameters:

param1 IR channel [0 ... 2]

Value	Meaning
0	Disable (Default value)
1	Video Input Reference
2	Reference Input

#blacklev Command

The #blacklev command sets the black level (RGB/Y) of the output signal. The default value is 0.

Syntax:

```
#blacklev param1
```

Parameters:

param1 Level value [0 ... 1023]

#bright Command

The #bright command sets the brightness value for a specific color. The default value for *param2* is 50.

Syntax:

```
#bright param1 param2
```

Parameters:

param1 Color name [0 ... 2]

Value	Meaning
0	Red
1	Green
2	Blue

param2 Color value [0 ... 100]

#cleanaper Command

The #cleanaper command sets the clean aperture level for each position and size. The default value for *param1* and *param2* is 100. The default value for *param3* and *param4* is 50.

Syntax:

```
#cleanaper param1 param2 param3 param4
```

Parameters:

param1 Horizontal size [1 ... 100]

param2 Vertical size [1 ... 100]

param3 Horizontal position [1 ... 100]

param4 Vertical position [1 ... 100]

RS-232 COMMANDS

#contrast Command

The `#contrast` command sets the contrast level for a specific color.
The default value for *param2* is 50.

Syntax:

```
#CONTRAST param1 param2
```

Parameters:

param1 Color name [0 ... 2]

Value	Meaning
0	Red
1	Green
2	Blue

param2 Contrast value [0 ... 100]

#enhance Command

The `#enhance` command sets the enhancement value. The default value is 0.

Syntax:

```
#enhance param1
```

Parameters:

param1 Enhancement value [0 ... 100]

RS-232 COMMANDS

#extract Command

The #extract command sets the extract aspect mode. The default value for *param1* is 100. The default value for *param2* and *param3* is 50.

Syntax:

```
#extract param1 param2 param3
```

Parameters:

<i>param1</i>	Extract size percentage	[1 ... 100]
<i>param2</i>	Horizontal position	[1 ... 100]
<i>param3</i>	Vertical position	[1 ... 100]

#filmmode Command

The #filmmode command enables / disables film mode. The default value is 0. See page 12 for more information on film mode.

Syntax:

```
#filmmode param1
```

Parameters:

<i>param1</i>	Value	[0 ... 1]
---------------	-------	-----------

Value	Meaning
0	Disable
1	Enable

RS-232 COMMANDS

#gamma Command

The #gamma command sets the gamma correction mode.

Syntax:

```
#gamma param1 param2
```

Parameters:

param1 Gamma correction mode [0 ... 3]

Value	Meaning
0	Default
1	sRGB
2	Custom
3	User table

param2 Mode [1, 3 ... 30]

Value	Meaning
3 - 30	Set for Custom mode
1	Set for User table

Notes:

If the Custom mode is used (*param1* = 2), then set the gamma coefficient value in the second parameter. The default value is 1. If User Table is used, then set the second parameter to 1 to set the user table currently saved in EEPROM memory. To write a new gamma LUT (Look-Up Table) file, you must use the updater with the following command:

```
updater %comport% GAMMA [filename].csv
```

If the Default or sRGB modes are used, then set the second parameter to 0. See page 38 for more information on using the gamma LUT format.

#help Command

The #help command displays the list of available RS-232 commands.

Syntax:

#help

Parameters:

None

#input Command

The #input command sets the input format of the image. Refer to the *Supported Video and Graphics Formats* table on pages 33 - 35.

Syntax:

#input param1

Parameters:

param1

Input format

[see format table]

RS-232 COMMANDS

#key Command

The #key command simulates the pressing of buttons on the IR Remote Control unit by spooling the name or the key (as a string) to the serial port. The full name of the button may be specified or the first letter of the button. Only one button can be specified at a time.

Syntax:

```
#key param1
```

Parameters:

param1

Value

[String]

Value	Meaning
menu (or m)	Menu button
up (or u)	Up button
down (or d)	Down button
left (or l)	Left button
right (or r)	Right button
enter (or e)	Enter button
source (or s)	Source button
output (or o)	Output button

Examples:

The following are equivalent commands that simulate pressing the Menu button on the IR Remote Control unit:

```
#key menu
```

```
#key m
```

#language Command

The #language command sets the current language of the built-in menu system.

Syntax:

```
#language param1
```

Parameters:

param1 Language [0 ... 1]

Value	Meaning
0	English
1	French

#linkconfin Command

The #linkconfin command changes the input link configuration. The default value for *param1* is 0.

Syntax:

```
#linkconfin param1
```

Parameters:

param1 Mode [0 ... 3]

Value	Meaning
0	Single Link
1	Dual Link YCbCr (4:4:4)
2	Dual Link RGB (4:4:4)
3	Dual Link 1080p/576p/480p

#linkconfout Command

The #linkconfout command changes the output link configuration. The default value for param1 is 0.

Syntax:

```
#linkconfout param1
```

Parameters:

param1

Mode [0 ... 3]

Value	Meaning
0	Single Link
1	Dual Link YCbCr (4:4:4)
2	Dual Link RGB (4:4:4)
3	Dual Link 1080p/576p/480p

#list Command

The #list command displays the list of all the available commands that can be executed on the serial port. It also gives the number of parameters that each command requires.

Syntax:

```
#list
```

Parameters:

None

#motionthres Command

The #motionthres command sets the motion threshold value. The default value of param1 is 4.

Syntax:

```
#motionthres param1
```

Parameters:

param1

Value

[0 ... 15]

#noisereduc Command

The #noisereduc command sets the noise reduction value. The default value for *param1* is 0.

Syntax:

```
#noisereduc param1
```

Parameters:

<i>param1</i>	Value	[0 - 100]
---------------	-------	-----------

#noisethres Command

The #noisethres command sets the noise threshold. The default value for *param1* is 0.

Syntax:

```
#noisethres param1
```

Parameters:

<i>param1</i>	Value	[0 ... 100]
---------------	-------	-------------

#output Command

The #output command sets the output format of the image. Refer to the *Supported Video and Graphics Formats* table on pages 33 - 35.

Syntax:

```
#output param1
```

Parameters:

<i>param1</i>	Value	[see output table]
---------------	-------	--------------------

#pattern Command

The #pattern command selects the test patten image on the output port.

Syntax:

#pattern param1

Parameters:

param1

Pattern

[0 ... 3]

Value	Meaning
0	No pattern
1	Color bar
2	Cross hatch

#rb Command

The #rb command resets the 3GSDI to 3GSDI Scaler.

Syntax:

#rb

Parameters:

None

#remotechan Command

The #remotechan command sets the IR remote control channel.

Syntax:

#remotechan param1

Parameters:

param1

Channel

[0 ... 3]

#restore Command

The #restore command restores all of the default parameters.

Syntax:

```
#restore
```

Parameters:

None

#save Command

The #save command saves all the current parameters in the PROM. These parameters will be reloaded upon the next boot-up.

Syntax:

```
#save
```

Parameters:

None

#sizepos Function

The #sizepos command sets the size and the position of the image. This option is not available in the panoramic aspect mode.

Syntax:

```
#sizepos param1 param2 param3 param4
```

Parameters:

<i>param1</i>	Horizontal size	[1 ... 100]
<i>param2</i>	Vertical size	[1 ... 100]
<i>param3</i>	Horizontal position	[0 ... 100]
<i>param4</i>	Vertical position	[0 ... 100]

Note:

The default value for *param1* is the current horizontal resolution.
The default value for *param2* is the current vertical resolution.
The default value for *param3* and *param4* is 0.

#through Function

The `#through` command defines a sub-window that is always centered on the screen. The position is the relative position of the window within the full picture. This feature allow you to display one selected section of the input picture without modifying its size.

Syntax:

```
#through param1 param2 param3 param4
```

Parameters:

<i>param1</i>	Horizontal size	[1 ... 100]
<i>param2</i>	Vertical size	[1 ... 100]
<i>param3</i>	Horizontal position	[0 ... 100]
<i>param4</i>	Vertical position	[0 ... 100]

#version Function

The `#version` command returns the version of the Host Firmware, the Kernel and the configuration (in that order).

Syntax:

```
#version
```

Parameters:

None

SUPPORTED VIDEO AND GRAPHICS FORMATS

Supported Video and Graphics Formats

The following table contains all supported video and graphic formats supported by the GefenPRO 3GSDI to 3GSDI Scaler. The Value column are parameters used by the RS-232 #output command (see page 29).

Input		Output	
Format	Value	Format	Value
480i	0	480i	0
480p @ 59.94	6	480p @ 59.94	6
576i	1	576	1
576p @ 50	7	576p	7
720p @ 23.98	15	720p @ 23.9	15
720p @ 24	14	720p @ 24	14
720p @ 25	13	720p @ 25	13
720p @ 29.97	12	720p @ 29.97	12
720p @ 30	11	720p @ 30	11
720p @ 50	10	720p @ 50	10
720p @ 60	8	720p @ 60	8
720p @ 59.94	9	720p @ 59.94	9
1035i @ 59.94	64	1035i @ 59.94	64
1035i @ 50	63	1035i @ 50	63
1080i @ 50	24	1080i @ 50	24
1080i @ 50M	25	1080i @ 50M	25
1080i @ 59.94	23	1080i @ 59.94	23
1080i @ 60	22	1080i @ 60	22
1080p @ 23.98	34	1080p @ 23.98	34
1080p @ 24	32	1080p @ 24	32
1080p @ 25	30	1080p @ 25	30
1080p @ 29.97	28	1080p @ 29.97	28
1080p @ 30	26	1080p @ 30	26
1080p @ 50	20	1080p @ 50	20
1080p @ 50M	21	1080p @ 50M	21
1080p @ 59.94	19	1080p @ 59.94	19
1080p @ 60	18	1080p @ 60	18
1080sf @ 23.98	35	2K-p @ 23.98	75

SUPPORTED VIDEO AND GRAPHICS FORMATS

Input		Output	
Format	Value	Format	Value
1080sf @ 24	33	2K-p @ 24	76
1080sf @ 25	31	640 x 350 @ 85	36
1080sf @ 29.97	29	640 x 400 @ 85	37
1080sf @ 30	27	640 x 480 @ 60	38
2K-p @ 23.98	73	640 x 480 @ 75	39
2K-p @ 24	74	640 x 480 @ 85	40
2K-sf @ 23.98	75	800 x 600 @ 60	41
2K-sf @ 24	76	800 x 600 @ 75	42
Auto Detect	255	800 x 600 @ 85	43
640 x 350 @ 85	36	1024 x 768 @ 60	44
640 x 400 @ 85	37	1024 x 768 @ 75	45
640 x 480 @ 60	38	1024 x 768 @ 85	46
640 x 480 @ 75	39	1280 x 854	65
640 x 480 @ 85	40	1152 x 864 @ 75	47
800 x 600 @ 60	41	1280 x 768 @ 60	48
800 x 600 @ 75	42	1280 x 960 @ 60	49
800 x 600 @ 85	43	1280 x 960 @ 85	50
1024 x 768 @ 60	44	1280 x 1024 @ 60	51
1024 x 768 @ 75	45	1280 x 1024 @ 75	52
1024 x 768 @ 85	46	1280 x 1024 @ 85	53
1280 x 854	65	1360 x 768 @ 60	54
1152 x 864 @ 75	47	1366 x 768 @ 60	56
1280 x 768 @ 60	48	1366 x 923 @ 50	55
1280 x 960 @ 60	49	1440 x 900 @ 60	66
1280 x 960 @ 85	50	1440 x 1080 @ 60	67
1280 x 1024 @ 60	51	1600 x 1024	68
1280 x 1024 @ 75	52	1600 x 1200 @ 60	57
1280 x 1024 @ 85	53	1600 x 1200 @ 65	58
1360 x 768 @ 60	54	1600 x 1200 @ 70	59
1366 x 768 @ 60	56	1600 x 1200 @ 75	69
1366 x 923 @ 50	55	1680 x 1050 @ 60	70
1440 x 900 @ 60	66	1920 x 1200 @ 60	71
1440 x 1080 @ 60	67	2048 x 1080	72

SUPPORTED VIDEO AND GRAPHICS FORMATS

Input		Output	
Format	Value	Format	Value
1600 x 1024	68		
1600 x 1200 @ 60	57		
1600 x 1200 @ 65	58		
1600 x 1200 @ 70	59		
1600 x 1200 @ 75	69		
1680 x 1050 @ 60	70		
1920 x 1200 @ 60	71		
2048 x 1080	72		

RACK MOUNT SAFETY INFORMATION

- a. Maximum recommended ambient temperature: 45 °C
- b. Increase the air flow to maintain the temperature inside the rack.
- c. Install the product evenly to avoid mechanical overload.

MOUNTING PLATE INSTALLATION

Rack mount ears are provided for installation of this unit into a 1U rack mount space.

1. Locate the side screws on the unit.
2. Remove the front 2 screws that are located closest to the front of the unit.
3. Using the removed screws, screw the rack mounting bracket into the unit.
4. Repeat the procedure on the opposite side of the unit.



APPENDIX A

Gamma LUT File Format

The Gamma Look Up Table can be programmed using the `GefenUpdater.exe` program from the Gefen software package. To do this, following the instructions below:

- 1 Create the Gamma LUT.
- 2 Create a standard ASCII text file with the following line:

```
GefenUpdater GAMMA filename.csv
```

where `filename.csv` is the name of the Gamma LUT file.
- 3 Save the file as `UpdateGamma.bat`. Make sure that the `GefenUpdater.exe` file resides in the same directory (or is in the path) as the `UpdateGamma.bat` file.
- 4 Connect a USB cable from the computer to the HD to 3GSDI Scaler.
- 5 Power on the HD to 3GSDI Scaler. Once the Scaler has powered up, run the `UpdateGamma.bat` file.

The LUT is a standard .CSV file. Each line contains Red, Green and Blue values separate by comma ",". A value must be between 0 and 1023. A file must contain 1024 lines:

```
1023,0,0          (Line 1)
1023,0,0
1023,0,0
1023,0,0
1023,0,0
1023,0,0
1023,0,0
...
...
1023,0,0          (Line 1024)
```

SPECIFICATIONS

Input Video Bandwidth.....	2 x 2.97 Gbps
Output Video Bandwidth.....	2 x 2.97 Gbps
SDI Inputs.....	(2) BNC, female
SDI Outputs.....	(2) BNC, female
Genlock Input.....	(1) BNC, female
Digital Audio S/PDIF Output.....	(1) RCA, female
USB Port.....	(1) Type B, female
RS-232 Port.....	(1) DB-9, female
AC Inlet.....	(1) IEC type
Power Supply.....	110/220V (internal)
Dimensions (W x H x D).....	16.8" x 1.75" x 7" (428mm x 44.5mm x 178mm)
Shipping Weight.....	6 lbs (2.72 kg)

WARRANTY

Gefen warrants the equipment it manufactures to be free from defects in material and workmanship.

If equipment fails because of such defects and Gefen is notified within two (2) years from the date of shipment, Gefen will, at its option, repair or replace the equipment, provided that the equipment has not been subjected to mechanical, electrical, or other abuse or modifications. Equipment that fails under conditions other than those covered will be repaired at the current price of parts and labor in effect at the time of repair. Such repairs are warranted for ninety (90) days from the day of reshipment to the Buyer.

This warranty is in lieu of all other warranties expressed or implied, including without limitation, any implied warranty or merchantability or fitness for any particular purpose, all of which are expressly disclaimed.

1. Proof of sale may be required in order to claim warranty.
2. Customers outside the US are responsible for shipping charges to and from Gefen.
3. Copper cables are limited to a 30 day warranty and cables must be in their original condition.

The information in this manual has been carefully checked and is believed to be accurate. However, Gefen assumes no responsibility for any inaccuracies that may be contained in this manual. In no event will Gefen be liable for direct, indirect, special, incidental, or consequential damages resulting from any defect or omission in this manual, even if advised of the possibility of such damages. The technical information contained herein regarding the features and specifications is subject to change without notice.

For the latest warranty coverage information, refer to the Warranty and Return Policy under the Support section of the Gefen Web site at www.gefen.com.

PRODUCT REGISTRATION

Please register your product online by visiting the Register Product page under the Support section of the Gefen Web site.



20600 Nordhoff St., Chatsworth CA 91311
1-800-545-6900 818-772-9100 fax: 818-772-9120
www.gefenpro.com support@gefenpro.com

