

Kramer Electronics, Ltd.



USER MANUAL

Model:

VP-747

Universal Presentation Matrix Switcher / Scaler

Contents

1	Introduction	1
1.1	About the VP-747	1
2	Getting Started	1
2.1	Quick Start	2
3	Overview	3
3.1	About HDMI	5
4	Your VP-747 Universal Presentation Matrix Switcher / Scaler	6
5	Installing on a Rack	11
6	Connecting the VP-747	12
6.1	Connecting Different Source Types	14
6.2	Connecting the Outputs	15
7	Connecting the VP-747 Control Ports	16
7.1	Connecting a PC (via RS-232)	16
7.2	Connecting the AUDIO CONTROL Port	17
7.3	Connecting the VP-747 to the Kramer VP-727T	18
7.4	Connecting the VP-747 via the ETHERNET port	19
8	Understanding the VP-747	19
8.1	Understanding the UNIVERSAL Inputs	19
8.2	Understanding the PREVIEW/PROGRAM Outputs	19
8.2.1	The Transition from Preview to Program	22
8.3	Switching/Scaling of an Input	22
8.4	Understanding the PIP Button Feature	23
8.5	Locking and Unlocking the Front Panel	24
9	Operating the VP-747	25
9.1	Operating via the OSD MENU Screen	25
9.1.1	Preview and Program Setting Commands	25
9.1.1.1	Preview and Program Input and Output Settings	29
9.1.2	The Transition Menu Items	31
9.1.3	The Audio Menu Items	32
9.1.4	The Utility Menu Items	33
9.1.4.1	Save Lock	34
9.1.4.2	Input Lock	34
9.1.4.3	Save/Recall/Erase Setting Commands	34
9.1.5	The Information Menu Items	34
9.2	Operating via the Front Panel LCD Display	35
9.3	Operating via the Infrared Remote Control Transmitter	36
9.4	Operating via the Ethernet	37
9.4.1	Installing and Running the Configuration Software	37
9.4.2	Configuring the Ethernet Connection	37
9.4.3	Control the VP-747 via the Ethernet/Serial Port	38



10	Technical Specifications	39
11	VP-747 Communication Protocol	40

Figures

Figure 1: VP-747 Universal Presentation Matrix Switcher / Scaler Front Panel	7
Figure 2: VP-747 Universal Presentation Matrix Switcher / Scaler Rear Panel	9
Figure 3: Connecting the VP-747	13
Figure 4: Connecting the INPUTS (an example)	14
Figure 5: Connecting the PREVIEW OUT / PROGRAM OUT Connectors	15
Figure 6: Connecting the PC	16
Figure 7: Connecting the VP-727A to the VP-747	17
Figure 8: Connecting the VP-747 to the VP-727T	18
Figure 9: Example showing the use of the PREVIEW and PROGRAM Output	21
Figure 10: Menu Screen Icons	25
Figure 11: Preview and Program Setting OSD Menus	25
Figure 12: Input Mode Setting Screen	29
Figure 13: Output Mode Setting Screen	30
Figure 14: Transition Screen	31
Figure 15: Audio Screen	32
Figure 16: Utility Screen	33
Figure 17: Info Screen	34
Figure 18: Example of how to use the LCD Display	35
Figure 19: Remote Transmitter	36
Figure 20: VP-747 Control Application Screen	38

Tables

Table 1: Front Panel VP-747 Universal Presentation Matrix Switcher / Scaler Features	8
Table 2: Rear Panel VP-747 Universal Presentation Matrix Switcher / Scaler Features	10
Table 3: Connecting the Different Source Types	14
Table 4: PIP Source Appearance Availability	23
Table 5: Preview and Program Setting OSD Menus	26
Table 6: Input Mode Functions	29
Table 7: Output Mode Functions	30
Table 8: Transition Screen Functions	31
Table 9: Audio Screen Functions	32
Table 10: Utility Screen Functions	33
Table 11: Remote Transmitter Functions	36
Table 12: VP-747 Control Application Menu	38
Table 13: Technical Specifications of the VP-747	39
Table 14: Set Commands	41

1 Introduction

Welcome to Kramer Electronics! Since 1981, Kramer Electronics has been providing a world of unique, creative, and affordable solutions to the vast range of problems that confront the video, audio, presentation, and broadcasting professional on a daily basis. In recent years, we have redesigned and upgraded most of our line, making the best even better! Our 1,000-plus different models now appear in 11 groups¹ that are clearly defined by function.

1.1 About the VP-747

The **VP-747** *Universal Presentation Matrix Switcher / Scaler* is a true multi-standard video to graphics scaler and seamless switcher with eight universal inputs comprised of five BNC connectors each of which can accommodate a composite video, s-Video (Y/C), component video (RGB/YUV), RGBS, or RGBHV signal. Input 1 and input 2 also accommodate DVI / HDMI² inputs. It has dual scalers, one for the preview and the other for the program output. Dual scalers are required to do "live" seamless transitions from one source to another. It is ideal for these typical applications:

- Presentation applications that require a preview option
- Projection systems in conference rooms, board rooms, auditoriums, hotels, and churches
- Presentations requiring seamless switching between inputs, using special effects, cuts and fades

The package includes these items: **VP-747** *Universal Presentation Matrix Switcher / Scaler*, power cord³, infrared remote control transmitter (including the required battery), null-modem adapter, and this user manual⁴.

2 Getting Started

We recommend that you:

- Unpack the equipment carefully and save the original box and packaging materials for possible future shipment
- Review the contents of this user manual
- Use Kramer high performance high resolution cables⁵

1 GROUP 1: Distribution Amplifiers; GROUP 2: Switchers and Matrix Switchers; GROUP 3: Control Systems; GROUP 4: Format/Standards Converters; GROUP 5: Range Extenders and Repeaters; GROUP 6: Specialty AV Products; GROUP 7: Scan Converters and Scalers; GROUP 8: Cables and Connectors; GROUP 9: Room Connectivity; GROUP 10: Accessories and Rack Adapters; GROUP 11: Sierra Products

2 The HDMI connector connects to a DVD source via the Kramer ADC DM/HF adapter

3 We recommend that you use only the power cord that is supplied with the machine

4 Download up-to-date Kramer user manuals from the Internet at this URL: <http://www.kramerelectronics.com>

5 The complete list of Kramer cables is on our Web site at <http://www.kramerelectronics.com>



2.1 Quick Start

This quick start chart summarizes the basic steps when connecting a VP-747:

Step 1: Mount the machine - see section 5

Mount the machine in a rack or stick the 4 rubber feet to the underside

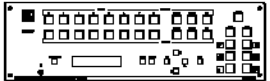

Step 2: Connect the inputs/outputs - see section 6

Connect the Inputs:

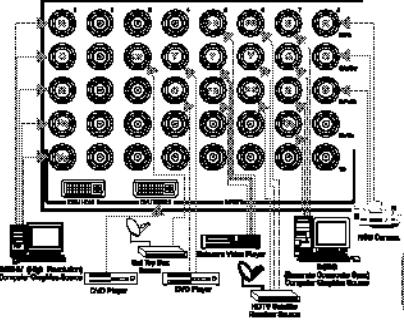

Connect the Preview/Program outputs:

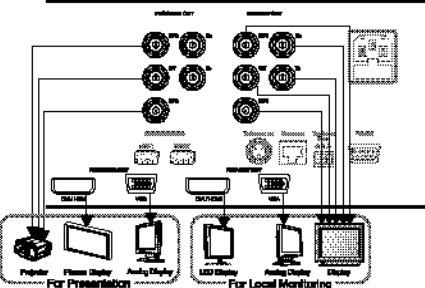

Step 3: Connect the control parts - see section 7

Connect to the control parts (optional): RS-232, RS-485, and/or the ETHERNET

Step 4: Turn the power ON

Step 5: Operate the machine - see sections 8 and 9

Select the Program and Preview Inputs

Switch Preview to program (with transition effects)

Select the transition mode

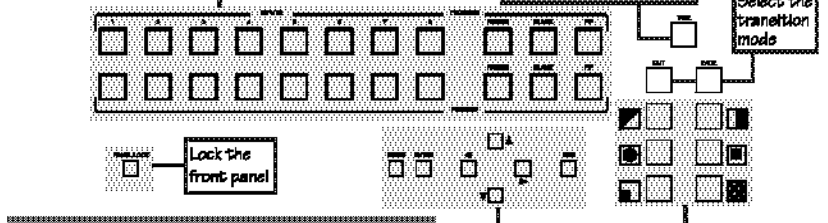

OPERATE VIA THE OSD



Operate via the front panel manu-driven OSD, LCD, IR remote control, RS-232, ETHERNET, and/or control panel

3 Overview

The **VP-747** *Universal Presentation Matrix Switcher / Scaler* is a true multi-standard video to graphics scaler and presentation switcher for a wide variety of presentation and multimedia applications. It consists of a very high quality scaler with many user-selectable graphics or HDTV output resolutions, as well as a user definable output mode¹.

The **VP-727A** *Audio Switcher* and **VP-727A-BA** *Balanced Audio Switcher* are audio companion switchers for the **VP-747**, and either can operate in conjunction with it and the **VP-727T** *Presentation Switcher Control Panel*.

In particular, the **VP-747**:

- Features Silicon Optix HQV® Video Processing (Hollywood Quality Video) which represents the state-of-the-art in video processing technology, with the highest quality de-interlacing, noise reduction, and scaling performance for both standard-definition and high-definition signals
- Features eight sets of universal INPUT BNC connectors: R/PR, G/Y/CV, B/PB/C, HS/CS, and Vs. Each set can be programmed to operate as: composite video, s-Video, component video², RGsB/YUV, RGBS, or RGBHV
- Includes two DVI / HDMI³ inputs (for input 1 and input 2) that support up to 1.65 / 2.25Gbps bandwidth per graphic channel⁴
- Is HDTV Compatible and HDCP compliant⁵
- Scales the selected sources to DVI / HDMI, RGBHV (Y, Pb, Pr) and VGA outputs simultaneously
- Has dual scalers—for “live” seamless transitions from one source to another—with two independent outputs: a PREVIEW OUT and a PROGRAM OUT (see [Section 8.2](#)). The PREVIEW output—including an OSD menu for making adjustments—is for determining how the scaled output will look before displaying live during a presentation, as well as for setting the special effects that harmonize the transition when changing between sources. Both outputs have separate sets of connectors for DVI / HDMI, VGA (a 15-pin HD computer graphics video connector), and RGBHV / YPbPr (on BNC connectors)

¹ Recommended for advanced users only – non-standard settings may not be recognized by the display device

² Sometimes called YUV, or Y, B-Y, R-Y, or Y, Pb, Pr. The component input type (HDTV or YCbCr) may be set as HD or SD

³ The HDMI connector connects to a DVD source via the Kramer ADC DM/HF adapter

⁴ Suitable for resolutions up to UXGA at 60Hz, and for all HD resolutions

⁵ The HDCP (High Definition Content Protection) license agreement allows copy-protected data on the HDMI input to pass only to the HDMI output



- Features eight PREVIEW input buttons for switching a selected input to the PREVIEW output and eight PROGRAM input buttons for switching a selected input to the PROGRAM output
- Includes two transition modes (accessible via the OSD): the Swap mode and the Follow mode. When pressing the TAKE button in the Swap mode, the preview and program inputs switch positions; when pressing in the Follow mode, the program input follows the preview input
- Scales and zooms (to up to 400% of the original size)
- Offers high quality de-interlacing 3:2/2:2 pull down¹
- Features K-IIT XL™ Picture-in-Picture Image Insertion Technology with ultra stable picture-in-picture, picture-and-picture, and split screen capability for both the PREVIEW and the PROGRAM outputs. Any video source can be inserted into or positioned next to a computer graphics video source or vice versa with window positioning and sizing controls²
- Saves all settings in non-volatile memory in the unit
- Supports firmware upgrade via USB
- Features a sophisticated front panel lockout³
- Features a Take button for executing preview to program switching (with transition effects, which include cuts, fades, and wipes⁴)
- Has ProcAmp⁵ controls for both outputs
- Has multi-standard video support: PAL, SECAM, and NTSC (3.58/4.43)
- Has a built-in Time Base Corrector that stabilizes video sources with unstable sync
- Features multiple color space, outputting RGB or YUV
- Supports embedded audio on the HDMI inputs and outputs
- Digitally reprocesses the signal to correct mastering errors, and regenerates the video at a chosen line and pixel rate format, providing, for example, native-resolution video for LCD, DLP and Plasma displays
- Facilitates scaling of graphics resolutions to other resolutions
- Incorporates a unique graphics-scaling engine with image enhancement algorithms, which are built into the firmware

1 Accommodates the frame-rate of a converted movie (24 frames per second) to video frequencies (25 frames per second (PAL); 30 frames per second (NTSC))

2 See [Table 5](#)

3 See [Section 3.5](#)

4 The direction of the wipe may be selected by the user. The speed of each transition can be adjusted

5 Processing amplification enables adjustment of different video and audio signal parameters

- Is specifically designed to improve video quality by reducing chroma and temporal noise
- Reduces digital artifacts such as mosquito and block noise
- Comes in a rugged, professional 19" 3U rack-mountable metal enclosure
- Uses a universal 100-240VAC automatic power supply, and rear panel power switch

Control the **VP-747** via the:

- Front panel and a user-friendly menu-driven OSD (see [Section 9.1](#))
- High contrast LCD Display (see [Section 9.2](#))
- IR remote control transmitter (see [Section 9.3](#))
- ETHERNET/RS-232 (see [Section 9.4](#))
- Kramer **VP-727T Presentation Switcher Control Panel**¹

3.1 About HDMI

High-Definition Multimedia Interface (HDMI) is an uncompressed all-digital² audio/video interface, widely supported in the entertainment and home cinema industry. It delivers the highest high-definition image and sound quality. Note that Kramer Electronics Limited is an HDMI Adopter and an HDCP Licensee.

In particular, HDMI³:

- Provides a simple⁴ interface between any audio/video source, such as a set-top box, DVD player, or A/V receiver and video monitor, such as a digital flat LCD / plasma television (DTV), over a single lengthy⁵ cable
- Supports standard, enhanced, high-definition video, and multi-channel digital audio⁶ on a single cable
- Transmits all ATSC HDTV standards and supports 8-channel digital audio, with bandwidth to spare to accommodate future enhancements and requirements

1 See the separate user manual on our Web site at <http://www.kramerelectronics.com>

2 Ensuring an all-digital rendering of video without the losses associated with analog interfaces and their unnecessary digital-to-analog conversions

3 HDMI, the HDMI logo and High-Definition Multimedia Interface are trademarks or registered trademarks of HDMI licensing LLC

4 With video and multi-channel audio combined into a single cable, the cost, complexity, and confusion of multiple cables currently used in A/V systems is reduced

5 HDMI technology has been designed to use standard copper cable construction at up to 15m

6 HDMI supports multiple audio formats, from standard stereo to multi-channel surround-sound. HDMI has the capacity to support Dolby 5.1 audio and high-resolution audio formats



- Benefits consumers by providing superior, uncompressed digital video quality via a single cable¹, and user-friendly connector
- Is backward-compatible with DVI (Digital Visual Interface)
- Supports two-way communication between the video source (such as a DVD player) and the digital television, enabling new functionality such as automatic configuration and one-button play

HDMI has the capacity to support existing high-definition video formats (720p, 1080i, and 1080p/60), standard definition formats such as NTSC or PAL, as well as 480p and 576p.

Achieving the best performance means:

- Connecting only good quality connection cables, thus avoiding interference, deterioration in signal quality due to poor matching, and elevated noise levels (often associated with low quality cables)
- Avoiding interference from neighboring electrical appliances, making sure not to block the ventilation holes, and positioning your **VP-747** away from moisture, excessive sunlight and dust

4 Your VP-747 Universal Presentation Matrix Switcher / Scaler

Figure 1 and Table 1 define the front panel of the **VP-747**:

¹ HDMI provides the quality and functionality of a digital interface while also supporting uncompressed video formats in a simple, cost-effective manner

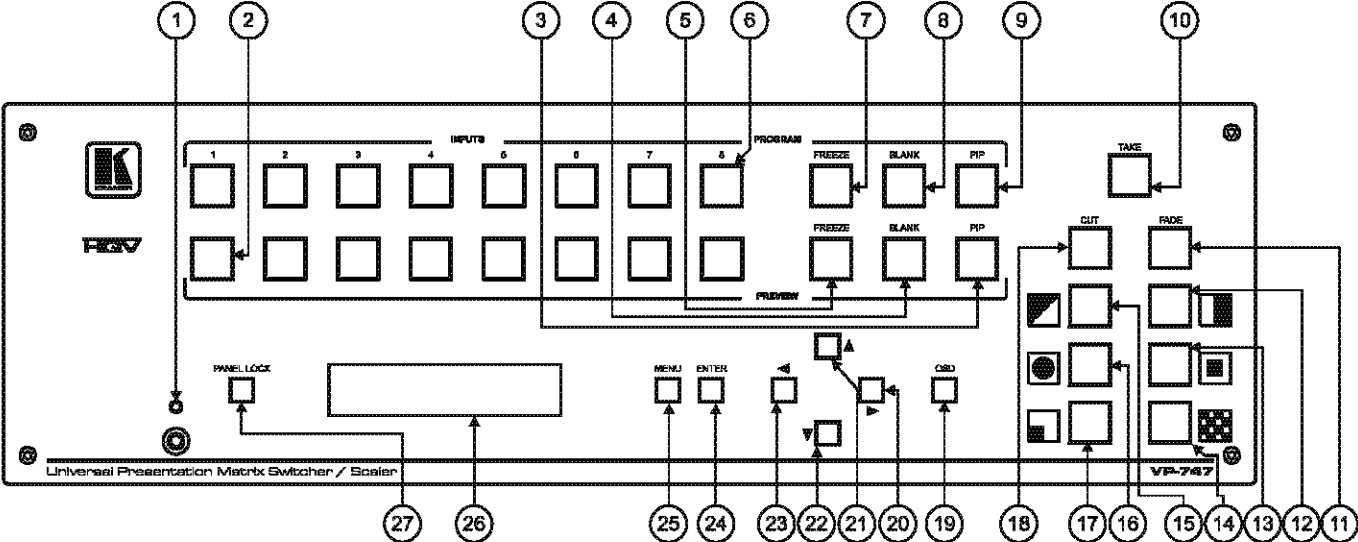

Figure 1: VP-747 Universal Presentation Matrix Switcher / Scaler Front Panel



Table 1: Front Panel VP-747 Universal Presentation Matrix Switcher / Scaler Features











#	Feature	Function	
1	IR Receiver / LED	Green when ON; red when OFF ¹	
2	PREVIEW Buttons	INPUTS	Selects the video source (from 1 to 8) ² for the Preview output
3		PIP	Toggles the picture-in-picture function on and off on the Preview output
4		BLANK	Toggles between a blank screen and the selected input on the preview output
5		FREEZE	Freezes the output video image (toggle) on the Preview output
6		INPUTS	Selects the video source (from 1 to 8) ² for the Program output
7	PROGRAM Buttons	FREEZE	Freezes the output video image (toggle) on the Program output
8		BLANK	Toggles between a blank screen and the selected input on the Program output
9		PIP	Toggles the picture-in-picture function on and off on the Program output
10	TAKE Button ³	Pressing TAKE causes the transition to occur	
11	FADE ⁸ Button	Selects a dissolved transition from the PREVIEW output to the PROGRAM output	
12	TRANSITION Buttons ^{3,4}		Selects a WIPE transition effect ⁵
13			Selects a SQUARE transition effect ⁶
14			Selects a CHESSBOARD transition effect ⁷
15			Selects a DIAGONAL transition effect ⁶
16			Selects a CIRCLE transition effect ⁷
17			Selects a CORNER transition effect ⁶
18	CUT ⁸ Button	Selects an instantaneous transition from the PREVIEW output to the PROGRAM output	
19	OSD Button	Activates/deactivates access to the OSD Menu on the Preview output	
20	NAVIGATION Buttons		Toggles within each level 2 command / increases the range by one step
21			Moves up one step (in the same level) in the OSD menu
22			Moves down one step (in the same level) in the OSD menu
23			Toggles within each level 2 command / decreases the range by one step
24	ENTER Button	Moves to the next level in the OSD menu	
25	MENU Button	Displays the OSD Menu screen (or moves to the previous level in the OSD menu)	
26	LCD STATUS Display	Displays the status of the unit, and is used for menu navigation	
27	PANEL LOCK Button	Locks/unlocks the front panel ⁹	

Figure 2 and Table 2 define the rear panel of the VP-747:

1 OFF in this case means that the outputs and the front-panel are disabled

2 From the five BNC (universal) inputs for each of the inputs. The INPUT buttons 1 and 2 can also select the DVI / HDMI sources

3 The effect is only seen in PROGRAM Mode. The PREVIEW screen will blank during the transition

4 Select a specific effect for the transition from the PREVIEW output to the PROGRAM output

5 To choose the direction from where the effect starts: "left to right", "right to left", "up" or "down", see [Section 9.1.2](#)

6 To choose the direction from where the effect starts: "top left", "bottom left", "top right" or "bottom right", see [Section 9.1.2](#)

7 To choose the direction of the effect: "in" or "out", see [Section 9.1.2](#)

8 Only for setting up the unit for the effect. The effect will only occur when the Take button is pressed

9 Press and hold for about 2 seconds to toggle

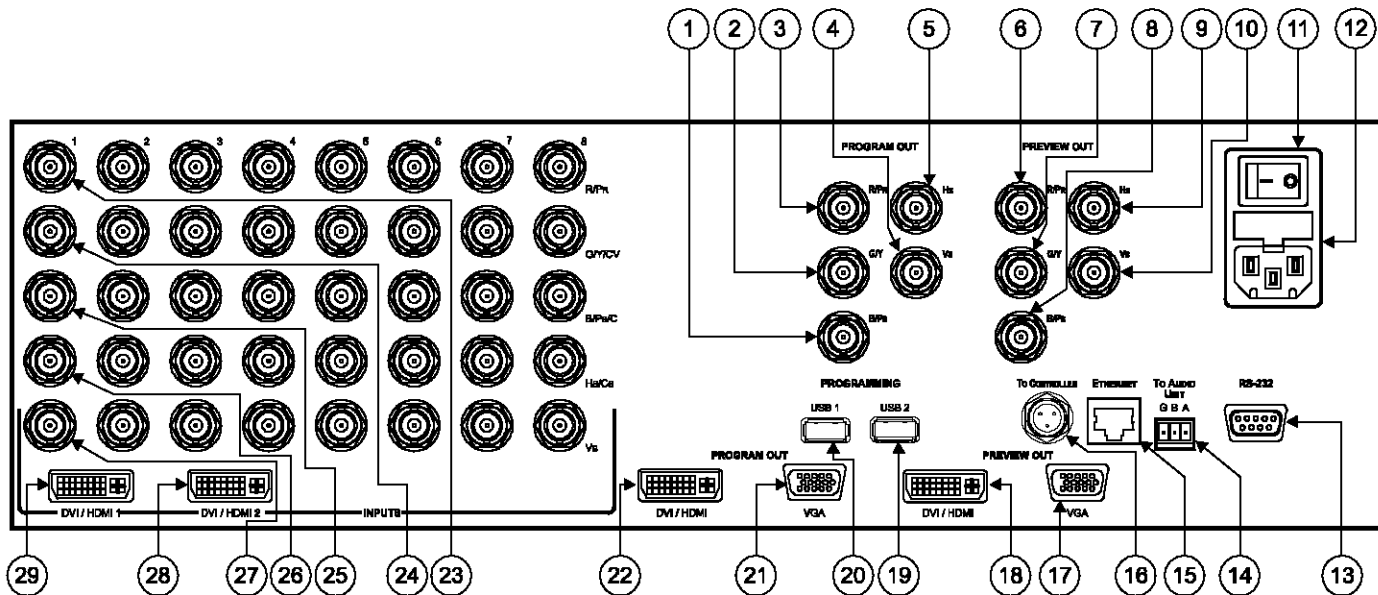

Figure 2: VP-747 Universal Presentation Matrix Switcher / Scaler Rear Panel



Table 2: Rear Panel VP-747 Universal Presentation Matrix Switcher / Scaler Features

#	Feature	Function
1	PROGRAM OUT	B/P _B BNC Connector
2		G/Y BNC Connector
3		R/P _R BNC Connector
4		V _S BNC Connector
5		H _S /C _S BNC Connector
6	PREVIEW OUT	R/P _R BNC Connector
7		G/Y BNC Connector
8		B/P _B BNC Connector
9		H _S /C _S BNC Connector
10		V _S BNC Connector
11	POWER Switch	Illuminated switch for turning the unit ON or OFF
12	Power Connector with FUSE	AC connector enabling power supply to the unit
13	RS-232 9-pin D-sub Connector	Connects to PC or Serial Controller
14	TO AUDIO UNIT Port	Connects to the Kramer VP-727A Audio Switcher (optional). Pins B (-) and A (+) are for RS-485; pin G may be connected to the Ground or the shield if desired;
15	ETHERNET Port	Connects to your LAN ²
16	TO CONTROLLER Mini XLR Connector	Connects to the Kramer VP-727T Presentation Switcher Control Panel (optional). Pins B (-) and A (+) are for RS-485; pin G may be connected to the Ground or the shield if desired
17	PREVIEW OUT	VGA 15-pin HD Connector
18		DVI / HDMI Connector
19	PROGRAMMING	USB 2 Connector
20		USB 1 Connector
21	PROGRAM OUT	VGA 15-pin HD Connector
22		DVI / HDMI Connector
23	INPUTS (from 1 to 8)	R/P _R BNC Connector
24		G/Y/CV BNC Connector
25		B/P _B /C BNC Connector
26		H _S /C _S BNC Connector
27		V _S BNC Connector
28	INPUTS	DVI / HDMI 2 Connector
29		DVI / HDMI 1 Connector

1 Sometimes called YUV; Y, B-Y, R-Y; Y, Pb, Pr; or Y, Cb, Cr

2 Local Area Network (that is, computers sharing a common communications line or wireless link, which often share a server within a defined geographic area)

3 Using a DVI/HDMI adapter or the Kramer C-HDMI/DVI HDMI to DVI Single Link (18 +1 pin) cable

4 Made up of the Y on the G/Y/CV connector together with the C on the B/Pb/C connector

5 Installing on a Rack

This section describes what to do before installing in a rack and how to rack mount.

Before Installing in a Rack

Before installing in a rack, be sure that the environment is within the recommended range:	
Operating temperature range	+5° to +45° C (41° to 113° F)
Operating humidity range	10 to 90% RHL, non-condensing
Storage temperature range	-20° to +70° C (-4° to 158° F)
Storage humidity range	5 to 95% RHL, non-condensing



CAUTION!!

When installing in a 19" rack, avoid hazards by taking care that:

1. It is located within the recommended environmental conditions, as the operating ambient temperature of a closed or multi unit rack assembly may exceed the room ambient temperature.
2. Once rack mounted, enough air will still flow around the machine.
3. The machine is placed straight in the correct horizontal position.
4. You do not overload the circuit(s). When connecting the machine to the supply circuit, overloading the circuits might have a detrimental effect on overcurrent protection and supply wiring. Refer to the appropriate nameplate ratings for information. For example, for fuse replacement, see the value printed on the product label.
5. The machine is earthed (grounded) in a reliable way and is connected only to an electricity socket with grounding. Pay particular attention to situations where electricity is supplied indirectly (when the power cord is not plugged directly into the socket in the wall), for example, when using an extension cable or a power strip, and that you use only the power cord that is supplied with the machine.

How to Rack Mount

To rack-mount a machine:

1. Attach both ear brackets to the machine. To do so, remove the screws from each side of the machine (3 on each side), and replace those screws through the ear brackets.

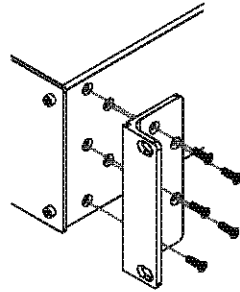

2. Place the ears of the machine against the rack rails, and insert the proper screws (not provided) through each of the four holes in the rack ears.

Note that:

- In some models, the front panel may feature built-in rack ears
- Detachable rack ears can be removed for desktop use
- Always mount the machine in the rack before you attach any cables or connect the machine to the power
- If you are using a Kramer rack adapter kit (for a machine that is not 19"), see the Rack Adapters user manual for installation instructions (you can download it at: <http://www.kramerelectronics.com>)

6 Connecting the VP-747

The **VP-747** is a universal presentation matrix switcher / scaler that lets you choose what sources to connect to the inputs. For example, you can connect just five sources: an RGBHV source, two DVI / HDMI sources, an HDTV source and an RGBS source (as the example in [Figure 3](#) shows).

To connect¹ the **VP-747** as illustrated in the example in [Figure 3](#), do the following:

1. Connect the following video sources:
 - An HDMI source to the INPUT DVI / HDMI 1 connector
 - An HDMI source to the INPUT DVI / HDMI 2 connector
 - An HDTV satellite receiver source to the R/PR, G/Y/CV, and B/PB/C BNC INPUT 6 connectors (PR/Y/PB)
 - An RGBHV computer graphics source to the R/PR, G/Y/CV, B/PB/C, HS/CS and V BNC INPUT 8 connectors (R, G, B, H, V)
2. Connect the PROGRAM OUT:
 - DVI / HDMI connector to the plasma display
 - VGA 15-pin HD connector to the analog display
 - R/PR, G/Y, B/PB, (PR, Y, PB) BNC OUTPUT connectors to the YUV acceptor, for example, a projector (PR, Y, PB)
3. Connect the PREVIEW OUT R/PR, G/Y, B/PB, HS and VS BNC OUTPUT connectors to the display (R, G, B, H, V)
4. Connect the power cord².
5. If required, connect:
 - A PC via RS-232, see [Section 7.1](#)
 - The Kramer **VP-727A Audio Switcher** via the To AUDIO UNIT RS-485 port³, see [Section 7.2](#)
 - The Kramer **VP-727T Presentation Switcher Control Panel** via the TO CONTROLLER mini XLR port³
 - The ETHERNET port³, see [Section 7.4](#)

1 Switch OFF the power on each device before connecting it to your VP-747. After connecting your VP-747, switch on its power and then switch on the power on each device

2 We recommend that you use only the power cord that is supplied with this machine

3 Not shown in [Figure 3](#) (see [Section 7.3](#))

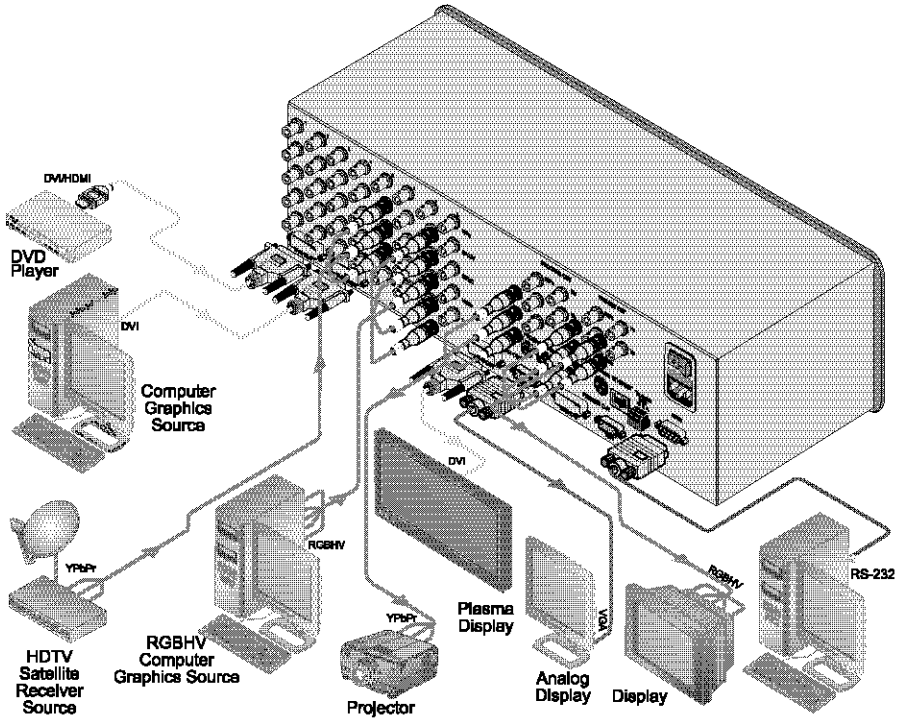

Figure 3: Connecting the VP-747

6.1 Connecting Different Source Types

As the **VP-747** is universal, you can connect any type (format) of video to the inputs. [Figure 4](#) and [Table 3](#) show an example of how to connect eight sources to the rear panel of the **VP-747**: an RGBHV source, an HDMI source, a CV source, a Y/C source, a component video source, an HDTV source, an RGBCs source and an RGB source.

Table 3: Connecting the Different Source Types

	Input 1:	Input 2:	Input 3:	Input 4:	Input 5:	Input 6:	Input 7:	Input 8:
	RGBHV	HDMI	CV	Y/C	Component	HDTV	RGBCs	RGB
R/PR	R				PR	PR	R	R
G/Y/CV	G		CV	Y	Y	Y	G	G
B/PB/C	B			C	PB	PB	B	B
HS/CS	HS						CS	
VS	VS							
HDMI		HDMI						

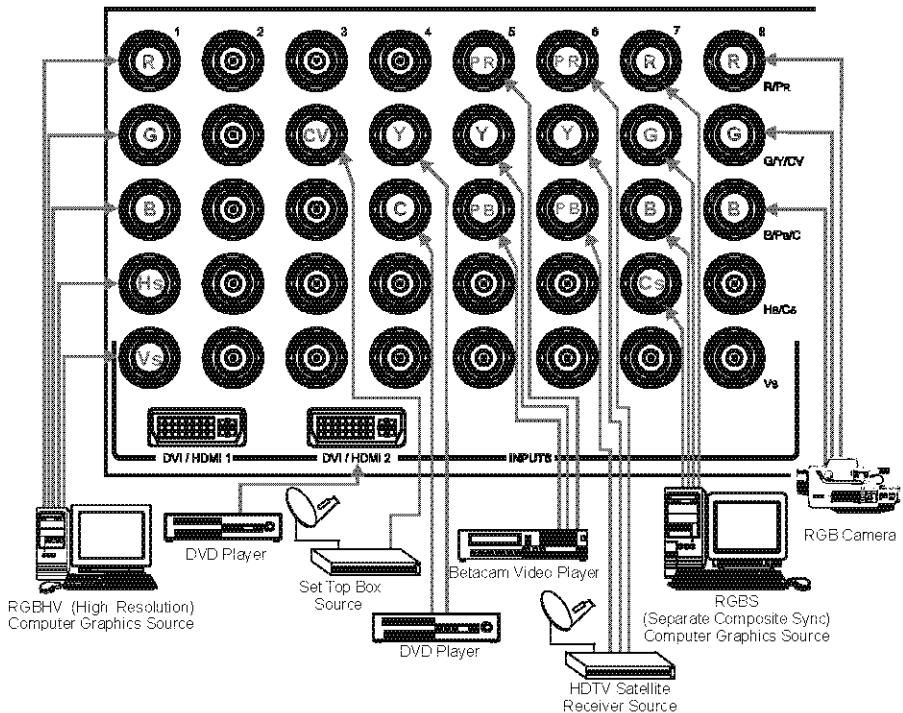

Figure 4: Connecting the INPUTS (an example)

6.2 Connecting the Outputs

Figure 5 illustrates an example of the different connection types available for the Preview and Program outputs:

For PROGRAM OUT, connect the:

- R/PR, G/Y, B/PB, (PR, Y, PB) BNC OUTPUT connectors to the YUV acceptor, for example, a projector
- HDMI connector to a plasma display
- VGA a 15-pin HD computer graphics video connector to an analog display

For PREVIEW OUT, connect the:

- HDMI connector to an LCD display
- VGA 15-pin HD computer graphics video connector to an analog display
- R/PR, G/Y, B/PB, HS and VS BNC OUTPUT connectors to a display

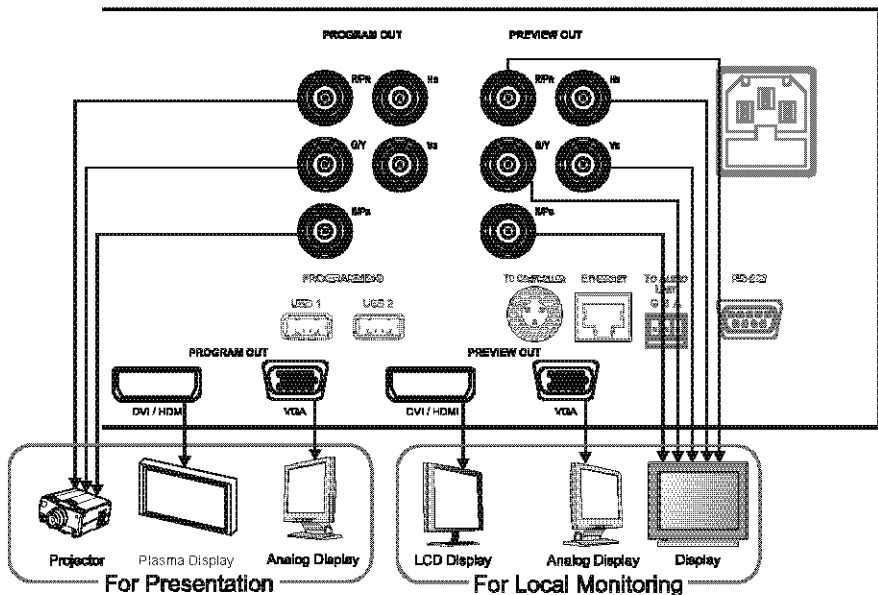

Figure 5: Connecting the PREVIEW OUT / PROGRAM OUT Connectors

7 Connecting the VP-747 Control Ports

This section describes how to connect the **VP-747** control ports, that is, the:

- RS-232 port, see [Section 7.1](#)
- TO AUDIO UNIT port, see [Section 7.2](#)
- TO CONTROLLER port, see [Section 7.3](#)
- ETHERNET port, see [Section 7.4](#)

7.1 Connecting a PC (via RS-232)

You can connect a PC (or other controller) to the **VP-747** via the RS-232 port for remote control.

To connect a PC to a **VP-747** unit, using the Null-modem adapter provided with the machine (recommended):

- Connect the RS-232 9-pin D-sub rear panel port on the **VP-747** unit to the Null-modem adapter and connect the Null-modem adapter with a 9-wire flat cable to the RS-232 9-pin D-sub port on your PC

To connect a PC to a **VP-747** unit, without using a Null-modem adapter:

- Connect the RS-232 9-pin D-sub port on your PC to the RS-232 9-pin D-sub rear panel port on the **VP-747** unit, forming a cross-connection¹, as [Figure 6](#) illustrates

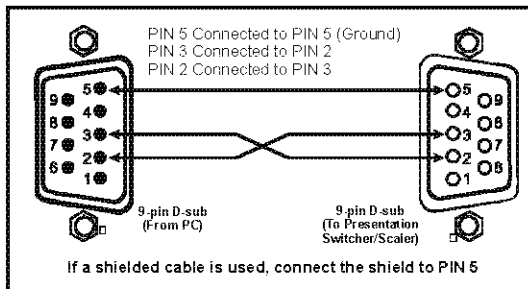

Figure 6: Connecting the PC

¹ Also known as a null-modem connection

7.2 Connecting the AUDIO CONTROL Port

The Kramer **VP-727A Audio Switcher** operates in conjunction with the **VP-747**. When connected, the audio switcher signals follow the video signals¹.

To connect the **VP-747** to the Kramer **VP-727A Audio Switcher** via the TO AUDIO UNIT RS-485 port, as illustrated in the example in [Figure 7](#), do the following:

- Connect the “A” (+) PIN on the AUDIO CONTROL RS-485 rear panel port of the **VP-747** to the A (+) PIN on the RS-485 rear panel port of the **VP-727A** unit
- Connect the “B” (-) PIN on the AUDIO CONTROL RS-485 rear panel port of the **VP-747** to the B (-) PIN on the RS-485 rear panel port of the **VP-727A** unit
- If shielded twisted pair cable is used, the shield may be connected to the “G” (Ground) PIN on one of the units

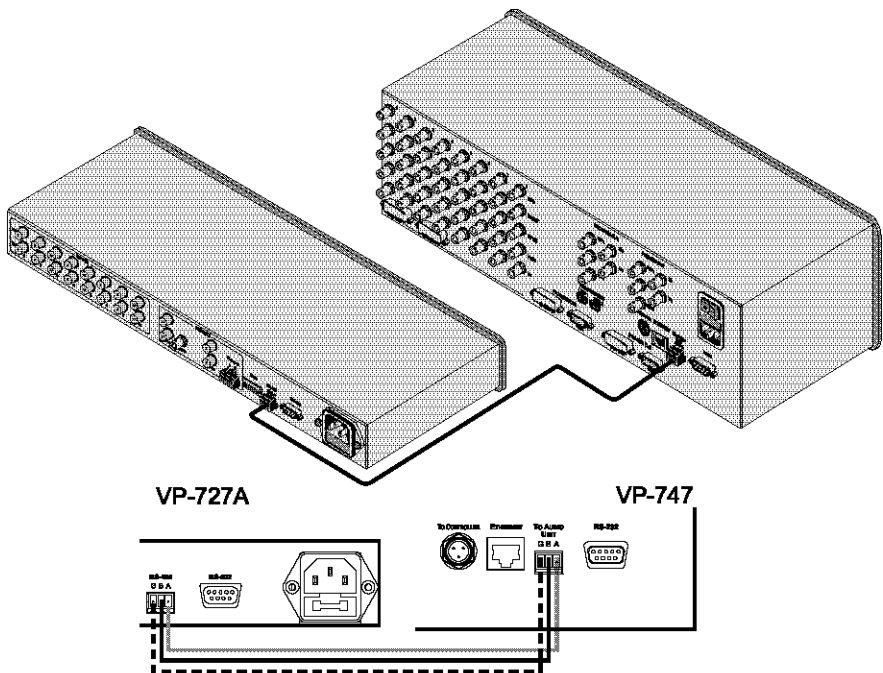

Figure 7: Connecting the VP-727A to the VP-747

¹ See the separate VP-727A user manual on our Web site at <http://www.kramerelectronics.com>



7.3 Connecting the VP-747 to the Kramer VP-727T

To connect the **VP-747** to the Kramer **VP-727T Presentation Switcher Control Panel**¹ via the mini XLR connector, as illustrated in, do the following:

- Connect the “A” PIN on the TO CONTROLLER mini XLR connector of the **VP-747** to the A (+) PIN on the RS-485 rear panel port of the **VP-727T** unit
- Connect the “B” (-) PIN on the TO CONTROLLER mini XLR connector of the **VP-747** to the B (-) PIN on the RS-485 rear panel port of the **VP-727T** unit
- If shielded twisted pair cable is used, the shield may be connected to the “G” (Ground) PIN on one of the units

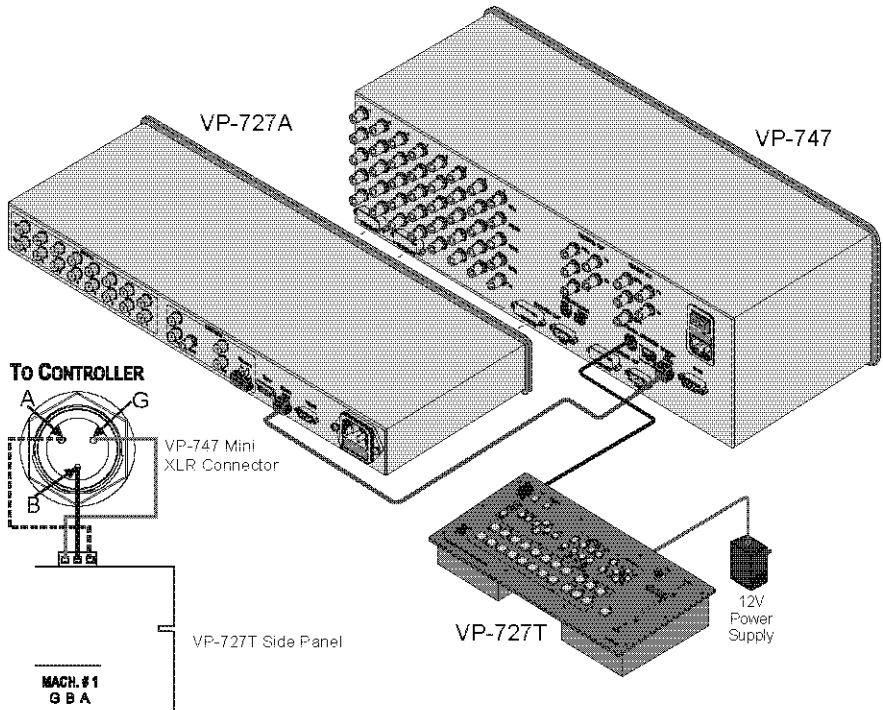

Figure 8: Connecting the VP-747 to the VP-727T

It is recommended that the PROGRAM and PREVIEW are set with the same output resolution for the best results when working with the T-Bar

¹ See the separate VP-727T user manual on our Web site at <http://www.kramerelectronics.com>

7.4 Connecting the VP-747 via the ETHERNET port

To connect the **VP-747** via the ETHERNET port, do the following:

Connect the ETHERNET port of the **VP-747** to the LAN port of your PC, via a crossover cable with RJ-45 connectors.

If connecting the ETHERNET port of the **VP-747** to the LAN port on a network hub or network router, use a straight-through cable with RJ-45 connectors.

8 Understanding the VP-747

This section describes the:

- UNIVERSAL inputs, see [Section 8.1](#)
- PREVIEW/PROGRAM outputs, see [Section 8.2](#)
- Switching/Scaling of an input, see [Section 8.3](#)
- PIP feature, see [Section 8.4](#)
- Panel Lock, see [Section 8.5](#)

8.1 Understanding the UNIVERSAL Inputs

The **VP-747** has eight sets of inputs¹; each set can be programmed to operate as composite video, s-Video, component video, RGB/YUV, RGBS, RGsB, or RGBHV. INPUT 1 and INPUT 2 can also accept DVI/HDMI inputs.

The **VP-747** is a **universal** presentation matrix switcher / scaler: you choose what type of source to connect to each input. You can connect different video types or the same or similar video types. See the examples in [Figure 3](#) and [Figure 4](#) in [Section 6](#).

8.2 Understanding the PREVIEW/PROGRAM Outputs

The **VP-747** has two outputs: a PREVIEW output, and a PROGRAM output. Each of these outputs functions independently and has DVI / HDMI connectors and VGA connectors, as well as sets of five BNC connectors²: R/Pr, G/Y, B/Pb, Hs, and Vs.

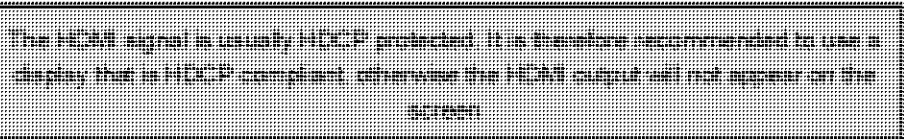

¹ Each set consists of five BNC connectors: R/Pr, G/Y/CV, B/Pb/C, Hs/Cs, and Vs

² Used to output one of the following: RGB, RGBHV, or component video



Using the **PREVIEW** output, you can:

- See how the scaled output will look before displaying live during a presentation. As the example in [Figure 9](#) illustrates, after seeing how the RGB source looks when scaled to HDMI, it can be interchanged with the YUV source, seamlessly, using an elaborate (in this case chessboard) transition effect
- Harmonize transition to the PROGRAM output after determining the look and feel when in the PREVIEW output
- Use the OSD menu to make adjustments and choose the settings
- Set the transition, choosing one of any eight special effects

Using the **PROGRAM** output, after pressing the TAKE button, you can see the transition¹. The PREVIEW output is not available during the transition period.

¹ After making some changes in the unit (for example, selecting a new input to the PREVIEW output), the TAKE button will be turned off (not illuminated) momentarily (until the unit successfully locks to this input). The TAKE button should not be pressed until it lights up again

1. In this example an RGBS source is connected to input 2, and a Component source is connected to input 3. Set the OSD Settings as follows:

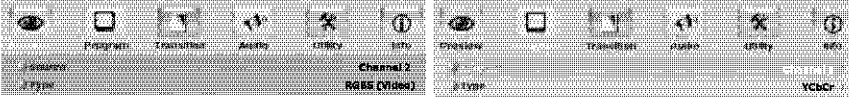

The PROGRAM INPUT button 3 and the PREVIEW INPUT button 2 illuminate:

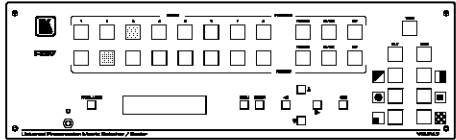

2. During the presentation, the Component source is outputted via the DVI/HDMI PROGRAM OUT connector. Before changing to the RGBS source, the demonstrator previews how that source currently looks on his local display:

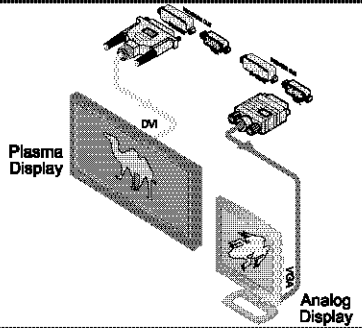

3. Pressing the Chessboard button and then the TAKE button causes the transition to occur. The PROGRAM INPUT button 2 illuminates to correspond with the PREVIEW INPUT button 2. The RGBS and component sources are swapped on the PREVIEW and PROGRAM outputs:

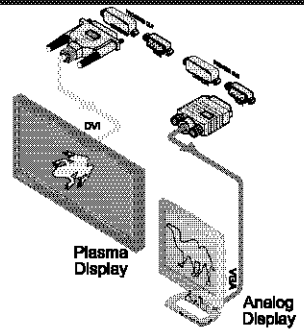
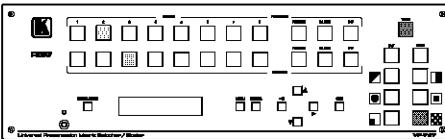

Figure 9: Example showing the use of the PREVIEW and PROGRAM Output

8.2.1 The Transition from Preview to Program

The transition can occur in one of two modes¹:

- The Swap² mode (shown in [Figure 9](#)), in which the PREVIEW input buttons and the PROGRAM input buttons switch places after pressing the TAKE button. For example, in [Figure 9](#) the PROGRAM input button 3 would switch to 2 and the PREVIEW input button 2 would switch to 3, so the RGBS source is displayed on the PROGRAM screen and the Component source is displayed on the PREVIEW screen.
- The Follow mode in which the PROGRAM input button is switched to the same position as the PREVIEW input button after the TAKE button is pressed

8.3 Switching/Scaling of an Input

The **VP-747** scales the selected sources³ to HDMI, RGBHV or YUV and VGA simultaneously. It switches seamlessly between sources using the selected special effects, which include cuts, fades, and wipes. Select the appropriate source (from channel 1 to 8) via the Input command in both the Preview Setting OSD screen and/or the Program Setting OSD screen (see [Section 9.1.1](#)), via the IR or front panel pushbuttons, or via the serial or Ethernet control.

¹ As selected via the Transition OSD Menu, see [Section 9.1.2](#)

² Swap mode is the default for the VP-747

³ Composite video, s-Video, component video (sometimes called YUV or Y, B-Y, R-Y or Y, Pb, Pr), RGB/YUV, RGBS, RGsB, or RGBHV

8.4 Understanding the PIP Button Feature

The Picture-in-Picture inserter (PIP) is used for the simultaneous display of video and graphic sources¹, and lets you display an inserted video PIP source over a graphic source², or an inserted graphic PIP source over a video source³, compliant to [Table 4](#). Both the Preview and Program outputs can support the PIP function.

Table 4: PIP Source Appearance Availability

		PIP Source							
		VIDEO		GRAPHIC					
VIDEO	Main Source	CV	YC	COMP	RGB/YUV	RGBS	RGsB	RGBHV	HDMI
	VIDEO	CV	No	No	Yes	Yes	Yes	Yes	Yes
YC		No	No	Yes	Yes	Yes	Yes	Yes	Yes
GRAPHIC	COMP	Yes	Yes	No	No	No	No	No	No
	RGB/YUV	Yes	Yes	No	No	No	No	No	No
	RGBS	Yes	Yes	No	No	No	No	No	No
	RGsB	Yes	Yes	No	No	No	No	No	No
	RGBHV	Yes	Yes	No	No	No	No	No	No
	HDMI	Yes	Yes	No	No	No	No	No	No

Select the PIP source (from channel 1 to 8), via the PIP source command in both the Preview Setting OSD screen and/or the Program Setting OSD screen.

Activate the PIP Feature by:

- Pressing the PIP front panel button
- Switching on the PIP functionality via the OSD Menu (see [section Table 5](#))
- Pressing the PIP key on the remote control transmitter (see [Section 9.3](#))
- Selecting the Serial or the Ethernet port
- Pressing the PIP button on the **VP-727T Presentation Switcher Control Panel**

Use the OSD menu (see [Section 9.1.1](#)) to:

- Select the PIP type
- Resize the PIP
- Create a PIP frame

¹ Since the HDMI signal is HDCP protected, an HDMI signal cannot appear on a display that is not HDCP compliant

² For example, a composite video or s-Video PIP source inserted over a component, RGB/YUV, RGBS, RGsB, or RGBHV graphic source

³ For example, a component (graphics), RGB/YUV, RGBS, RGsB, or RGBHV graphic PIP source inserted over a composite video, s-Video, or component (video) video source



8.5 Locking and Unlocking the Front Panel

To prevent changing the settings accidentally or tampering with the unit via the front panel buttons, lock your **VP-747**. Unlocking releases the protection mechanism. When the front panel is locked, control is still available via RS-232, the ETHERNET, and/or the CONTROL connector.

To lock the **VP-747**:

- Press and hold for a few seconds the PANEL LOCK button¹ on the front panel
The front panel is locked and the PANEL LOCK button is illuminated.
Pressing a button will have no effect

To unlock the **VP-747**:

- Press and hold for a few seconds the illuminated PANEL LOCK button¹ on the front panel
The front panel unlocks and the PANEL LOCK button is no longer illuminated

For a description of the Save Lock and Input Lock OSD functions, see [Section 9.1.4](#).

¹ Or the Lock key on the infrared remote control transmitter (see [Figure 19](#))

9 Operating the VP-747

You can operate the **VP-747** via the:

- OSD Menu, see [Section 9.1](#)
- LCD Display, see [Section 9.2](#)
- Infrared Remote Control Transmitter, see [Section 9.3](#)
- ETHERNET/RS-232, see [Section 9.4](#)

9.1 Operating via the OSD MENU Screen

The OSD superimposes a menu on the Preview screen from which you can control your **VP-747**. When the OSD front panel button is on, pressing the MENU button on the front panel or the Menu key on the infrared remote control transmitter displays the first OSD screen¹, the “Preview Setting” screen. If the OSD is off, pressing the MENU button on the front panel or the Menu key on the infrared remote control transmitter will not display the “Menu screen”. In this case, you can navigate via the front panel LCD. [Figure 10](#) defines the six interactive icons:



Figure 10: Menu Screen Icons

9.1.1 Preview and Program Setting Commands

[Figure 11](#) and [Table 5](#) define the Preview and Program Setting commands:

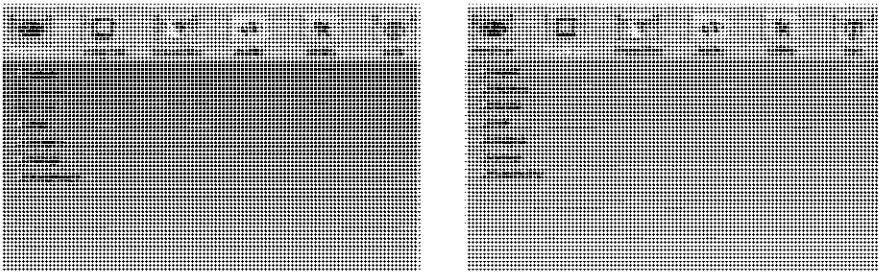

Figure 11: Preview and Program Setting OSD Menus

¹ Or the last used OSD screen

Table 5: Preview and Program Setting OSD Menus

Setting	Function	Selection/Range	Default
Input Sub-menu			
Source	Select the input source	Channel 1 to 8	Channel 1
Type	Set the video type	RGBHV, RGBS (PC/Video), RGsB (PC/Video), YCbCr, Y/C or video, HDMI (for input 1 and input 2 only)	RGBHV
Video Standard	Set the Video standard	Auto, NTSC, PAL, PAL-M, PAL-N, NTSC 4.43, SECAM or PAL 60	Auto
H-Position ¹	Set the horizontal position ²		
V-Position ¹	Set the vertical position		
Frequency ¹	Adjust the frequency ³		
Phase ⁴	Adjust the phase	0 to 31	0
Auto Image	Assesses the image and improves the quality accordingly, by automatically adjusting the phase, frequency and position. Upon completion, the relevant OSD values are updated (H-Position, V-Position, Phase and Frequency)		
Overscan	Allows stretching of the outputted picture	On or Off	On
Picture Sub-menu			
Brightness	Adjust the brightness	-50 to 50	0
Contrast	Adjust the contrast	-50 to 50	0
Color	Adjust the color	-50 to 50	0
Hue	Adjust the hue	-180 to 180	0
Sharpness	Adjust the sharpness	-50 to 50	0
Output Gamma	Adjust the gamma	1 to 4	1
Film Mode	Set the film mode	Auto, Video or Film	Auto
Temporal NR ⁵	Set the temporal noise reduction level	Off, Low, Medium or High	High
Mosquito NR ⁵	Set the Mosquito noise reduction level	Off, Low, Medium, High	Low
Block NR ⁵	Set the block noise reduction level:	Off or On	High
Detail Enhancement ⁵	Set the detail enhancement	Off, Low, Medium or High	Off
Luma Transition Enhance ⁵	Set the luminance transition enhance level:	Off, Low or High	Low
Chroma Transition Enhance ⁵	Set the chrominance transition enhance level:	Off, Low or High	Low

1 The range changes according to the input mode

2 For UXGA and component video inputs

3 For UXGA inputs

4 Only for a VGA Source

5 You do not have to press ENTER after selecting the desired parameter to change it

Setting	Function	Selection/Range	Default
Scale			
Aspect Ratio	Set the aspect ratio	Best Fit ¹ , Letterbox, Follow Output ² , Virtual Wide, Follow Input ³ , Custom	Best fit
H-Pan ⁴	Horizontal pan	-16 to 16	0
V-Pan ⁴	Vertical pan	-16 to 16	0
H-Zoom ⁴	Horizontal zoom	-8 to 8	0
V-Zoom ⁴	Vertical zoom	-8 to 8	0
Zoom	Set the Zoom ⁵ :	100%, 150%, 200%, 225%, 250%, 275%, 300%, 325%, 350%, 375%, 400%, Custom	100
Custom Zoom ⁶	Set the zoom:	from 0 to 32 (this range is equivalent to 100% to 400%)	0
Zoom H-Pan		-16 to 16	0
Zoom V-Pan		-16 to 16	0
PIP			
On/Off	Activate/deactivate the PIP feature ⁷	On/Off	Off
Type	Select the PIP type	Picture-In-Picture, Picture + Picture ⁸ or Split	Picture-In-Picture
Source	Select the PIP source ⁹ :	Channel 1 to Channel 8	
PIP Size	Select the PIP size	1/25, 1/16, 1/9, 1/4, or Custom	1/4
H - Position	Set the horizontal position of the PIP on the display	0 to 128	3
V - Position	Set the vertical position of the PIP on the display	0 to 128	0
H - Size	Set custom size ¹⁰	1 to 255	14
V - Size	Set custom size ¹⁰	1 to 255	5
Frame	Turn the PIP frame	On or Off	On
Frame Color	Select the color of the PIP frame	Red, Green or Blue	Blue

1 The best possible compromise between the input and the output aspect ratios without distorting or cropping the picture

2 Scales the picture to fill the entire output screen

3 Shows the picture without scaling it (pixel-to-pixel mapping)

4 Available when selecting Custom aspect ratio

5 The zoom feature is disabled in cases such as when the aspect ratio is set to custom or when the PIP feature is on

6 This function is available after setting the Zoom to custom

7 When PIP is activated and that input is not connected, the PIP window will appear black. If the zoom function is ON, the OSD prompts "cancel zoom?"

8 Maintains the aspect ratio

9 When changing the PIP source, the display fades through black

10 The actual range depends upon the input resolution



Setting	Function	Selection/Range	Default
Output			
Resolution	640x480x60Hz, 640x480x75Hz, 800x600x50Hz, 800x600x60Hz, 800x600x75Hz, 832x624x60Hz, 852x480x60Hz, 1024x768x50Hz, 1024x768x60Hz, 1024x768x75Hz, 1280x768x50Hz, 1280x768x60Hz, 1280x720x60Hz, 1280x800x60Hz, 1280x1024x50Hz, 1280x1024x60Hz, 1280x1024x75Hz, 1366x768x50Hz, 1366x768x60Hz, 1400x1050x50Hz, 1400x1050x60Hz, 1440x900x60Hz, 1600x1200x50Hz, 1600x1200x60Hz, 1680x1050x60Hz, 1920x1080x50Hz, 1920x1080x60Hz, 1920x1200x60Hz, 480px60Hz, 576px60Hz, 720px50Hz, 720px60Hz, 1080ix50Hz, 1080ix60Hz, 1080px50Hz, 1080px60Hz, 1080p@24Hz or Custom (from 1 to 4)		1024x768x60Hz
HQV Color Setting	Set the Red, Green, Blue, Cyan, Magenta and Yellow saturation	-100 to 100	0
Setup			
	Input Mode Setting (see Figure 12)		
	Output mode setting (see Figure 13)		
Geometry			
Application	Select the output application	Keystone, Anyplace or Rotation	keystone
Location	Select the location of the display	Front, Ceiling, Rear or Rear ceiling	Front
Horizontal Keystone	Adjust the horizontal keystone ²	-40 to 40	0
Vertical Keystone	Adjust the vertical keystone ³	-30 to 30	0
Diagonal Projection	Move the location of each corner of the display separately ⁴	Top Left, Top Right, Bottom Left, Bottom Right or Reset (to reset diagonal projections settings)	Top Left
Pincushion/Barrel	Adjust the pincushion or barrel appearance of the screen ⁵	-20 to 20	0
Rotation	Rotate the display clockwise or counterclockwise (in 1 increments)	-180 to 180	0
Reset all	Resets the geometry settings to their default values		

1 If the custom resolution is set to be the same as the default resolution, the scaler refers to the default resolution

2 If the projector is located at an angle to the left or right of the screen

3 If the projector is located at an angle above or below the screen

4 Horizontally and vertically

5 For projection onto curved surfaces

9.1.1.1 Preview and Program Input and Output Settings

Figure 12 and Table 6 define the input Mode Setting:

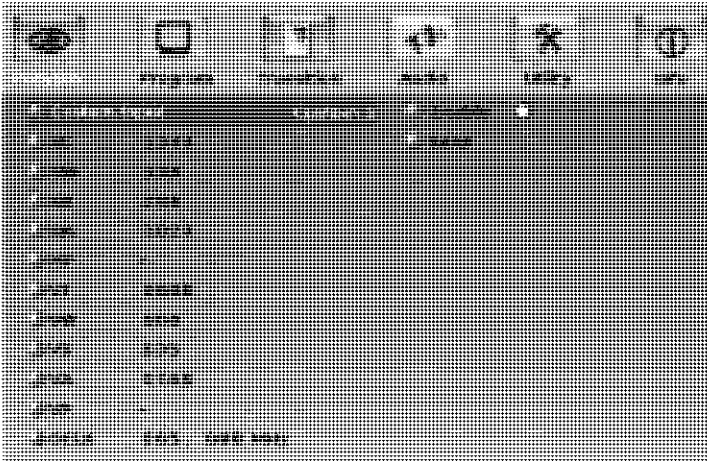

Figure 12: Input Mode Setting Screen

Table 6: Input Mode Functions

Setting	Function	Range	Default
Custom Input	Set custom values	Custom 1 to 4	
HT	Horizontal Total		1344
HW	Horizontal sync pulse width		136
HS	Horizontal active start point		296
HA	Horizontal active region		1024
HP	Horizontal polarity		
VT	Vertical Total		806
VW	Vertical sync pulse width		6
VS	Vertical active start point		35
VA	Vertical active region		768
VP	Vertical polarity		
OCLK	Output clock		65
Enable			off
Save	Click to save settings		N/A

Figure 13 and Table 7 define the output Mode Setting:

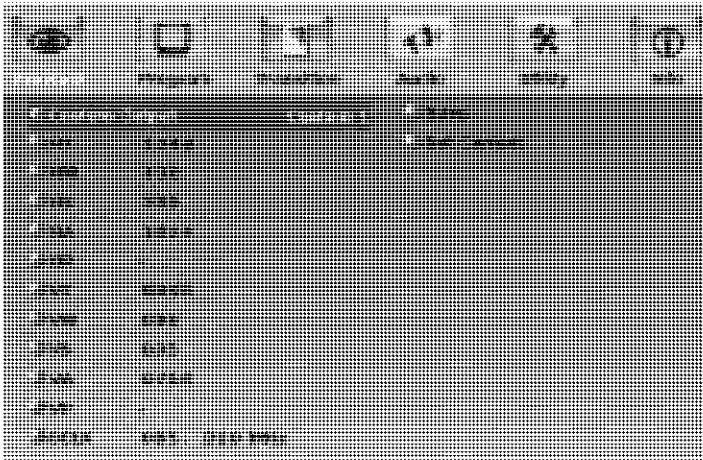

Figure 13: Output Mode Setting Screen

Table 7: Output Mode Functions

Setting	Function	Range	Default
Custom Output	Set custom values	Custom 1 to 4	
HT	Horizontal total		1344
HW	Horizontal sync pulse width		136
HS	Horizontal active start point		296
HA	Horizontal active region		1024
HP	Horizontal polarity		
VT	Vertical total		806
VW	Vertical sync pulse width		6
VS	Vertical active start point		35
VA	Vertical active region		768
VP	Vertical polarity		
OCLK	Output clock		65
Save	Click to save the settings		
Set Current	Import the values of the currently selected output resolution into the User Mode Setting		N/A

9.1.2 The Transition Menu Items

Figure 14 and Table 8 define the Transition screen.

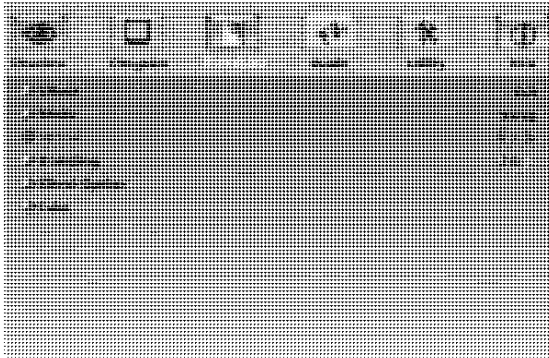

Figure 14: Transition Screen

Table 8: Transition Screen Functions

Setting	Function	Selection/Range	Default
Effect	Set the transition effect	Cut, Fade, Diagonal, Wipe, Circle, Square, Corner or Chessboard	Fade
Mode	Set the transition mode	Swap or Follow	Swap
Speed	Set the transition speed	1 to 5	3
Damping	Set the transition damping ¹	0 to 4	0
Effect Option	Diagonal:		Top Left
	Wipe:		Left to Right
	Circle:		Out
	Square		In
	Corner		Bottom Left
	Chessboard	<p>Each block performs as shown in the "Square" above</p>	In
Take ¹	Pressing causes the transition from preview to program (SWAP or FOLLOW)		

¹ When using the VP-747 together with the T-bar controller

9.1.3 The Audio Menu Items

The audio menu controls the **VP-727A** audio companion. See the **VP-727A** user manual for further detail². Figure 15 and Table 9 define the screen.

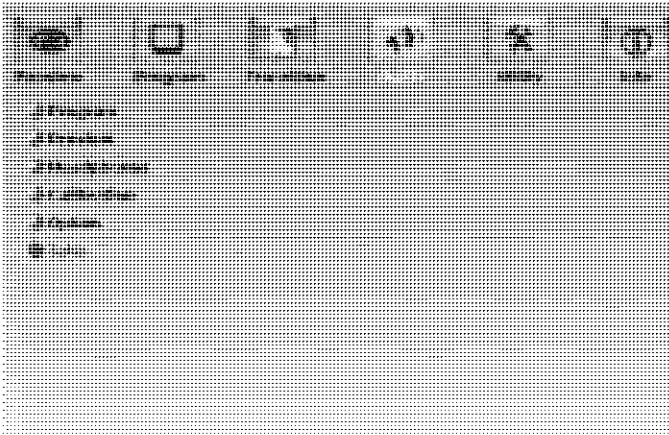

Figure 15: Audio Screen

Table 9: Audio Screen Functions

Setting	Function	Selection/Range	Default
Program	Source	Channel 1 to Channel 8	Channel 1
	Input Volume	-82 (mute) to +45	0
	Output Volume	-22 (mute) to +9	0
	Delay ³	0 to 127 [msec]	0
Preview	Source	Channel 1 to Channel 8	Channel 1
	Input Volume	-82 (mute) to +45	0
	Output Volume	-82 (mute) to +45	0
Headphones	Set the headphone source	Program or Preview	Program
	Volume	-12 (mute) to 4	0
Calibration	Bass	-6 to 6	0
	Treble	-6 to 6	0
	Balance	-10 to 10	0
Option	Audio-Follow-Video	Follow or audio breakaway	Follow
	Fade	On or Off	On
	Mute-Follow	Freeze, Blank or Freeze & Blank	none
Take	In the breakaway mode, preview and program audio inputs switch positions		

1 If the resolutions of Preview and Program are different, pressing the TAKE button when in the Freeze mode, will disable the Freeze mode

2 Download up-to-date Kramer user manuals from the Internet at this URL: <http://www.kramerelectronics.com>

3 Sets the pipeline delay of the audio (to compensate the delay in the video processing)

9.1.4 The Utility Menu Items

Figure 16 and Table 10 define the screen.

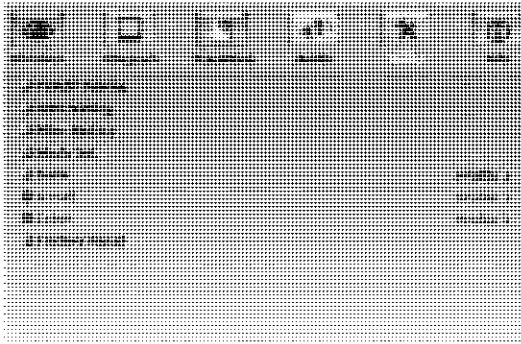

Figure 16: Utility Screen

Table 10: Utility Screen Functions

Setting	Function	Selection/Range	Default
TCP/IP Setting	DHCP	Off or On	Off
	IP Address		192.168.1.39
	Subnet Mask		255.255.255.0
	Gateway		192.168.1.254
	Apply	Apply settings	
OSD	Menu Position	Center, Top Left, Top Right, Bottom Left or Bottom Right	Center
	Time-Out	5, 10, 20, 30, 60, 90 seconds or Off	30 Sec
Misc. Settings	Logo	Off or On	On
	Save Lock (see Section 9.1.4.1)		
	Input Lock (see Section 9.1.4.2)	Off or On	On
	Background	Blue, Black or Disable Analog Sync	Black
	Blank Color	Black or Blue	
	Event Mode	Off or On	Off
	Baud Rate	9600 or 115200	115200
	Firmware Download		
	HDCP Setting	Follow Output or Follow Input	
Auto Image	Manual or Auto	Manual	
Mode Set	Mode 1	1400x1050@60Hz or 1680x1050@60Hz	1680x1050x60Hz
	Mode 2	1280x1024x75Hz or 1280x1024@76Hz	1280x1024x75Hz
	Mode 3	1280x768@60Hz or 1366x768@60Hz	1280x768x60Hz
Save	Save profile ¹	From 1 to 8	
recall	Recall profile ¹	From 1 to 8	
erase	Erase profile ¹	From 1 to 8 or all	
Factory reset			

¹ See Section 9.1.4.1



9.1.4.1 Save Lock

The Save Lock qualifies the Panel Lock¹. When set to On, the status of the Panel lock is saved on power down, and then recalled when the unit is turned on again².

9.1.4.2 Input Lock

The Input Lock qualifies the Panel Lock¹. When set to On, the 8x2 Input buttons and the TAKE button are included in the buttons which are locked³ when the Panel Lock is on.

9.1.4.3 Save/Recall/Erase Setting Commands

You can save/recall/ up to 8 settings. In each setting you can preserve the entire machine's settings⁴. All parameters are saved/recalled, including the Universal Input configurations, ProcAmp settings, output resolutions, and so on. You can also erase a single setting or all of them.

9.1.5 The Information Menu Items

From the Info screen (see [Figure 17](#)), you can verify the program and preview source, video type and video standard as well as the PIP program and PIP Preview source, video type and video standard. The Info screen also displays the Preview and Program output resolutions.

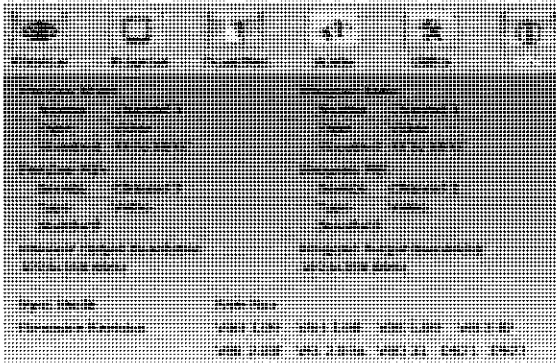

Figure 17: Info Screen

1 For a description of how to lock the front panel using the PANEL LOCK button, see [Section 3.5](#)

2 If the Save Lock is OFF, the Panel Lock will be OFF when the machine is powered up (even if the Panel Lock was ON before the power was turned OFF)

3 If the Input Lock is ON, access to the front panel buttons is blocked when Panel Lock is On, including the PROGRAM and PREVIEW INPUT selector front panel buttons, and the Program and Preview IR remote transmitter keys. When Input Lock is Off, then you can still access the 8x2 Input buttons and the TAKE button, even if the Panel Lock is On

4 This is useful, for example, for configuring the machine for multiple presentations. Up to 8 presentation configurations can be saved in the machine's memory

9.2 Operating via the Front Panel LCD Display

You can control the **VP-747** PREVIEW output from the front panel, high contrast, LCD Display, using the:

- Front panel OSD buttons: MENU, ENTER, ►, ◀, ▲, and ▼
- Infrared remote control transmitter (see [Figure 19](#)) keys: MENU, and the direction keys

For example, to set the time out to 60 seconds via the LCD Display, using the front panel buttons, do the following:

1. Turn the **VP-747** unit ON, and press the OSD ON button (if selected).
2. Press the appropriate front panel OSD buttons (as defined in [Figure 18](#)).

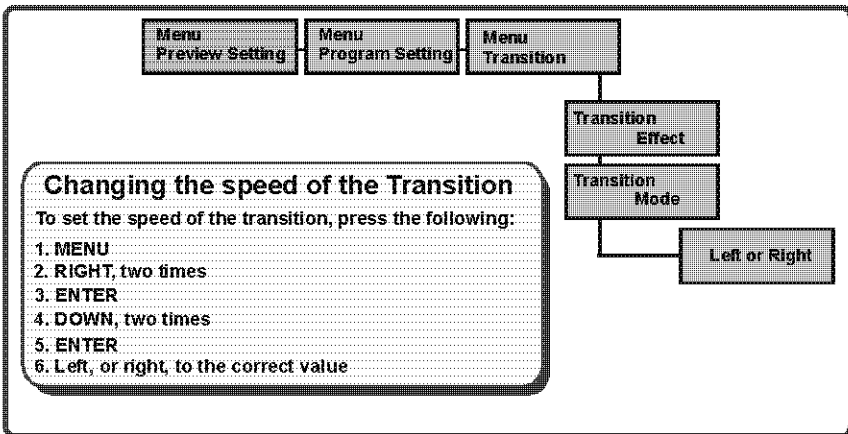

Figure 18: Example of how to use the LCD Display





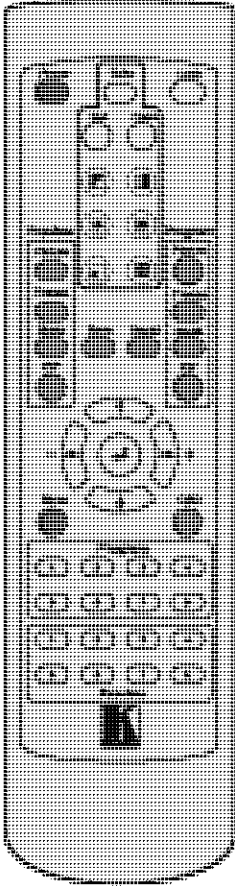

9.3 Operating via the Infrared Remote Control Transmitter

You can control the **VP-747** remotely, from the infrared remote control transmitter (that has a range of up to 15 meters and is powered by two AAA size 1.5V DC batteries), as defined in [Figure 19](#) and [Table 11](#):

Figure 19: Remote Transmitter

Table 11: Remote Transmitter Functions



Keys	Function	
Power	Cycles power ¹	
Take ²	Pressing TAKE causes the transition to occur	
Lock	Locks/unlocks the front panel	
Cut ³	Selects an instantaneous transition from the PREVIEW output to the PROGRAM output	
Fade ³	Selects a dissolved transition from the PREVIEW output to the PROGRAM output	
	Selects a DIAGONAL transition effect ^{4,3}	
	Selects a WIPE transition effect ^{5,3}	
	Selects a CIRCLE transition effect ^{6,3}	
	Selects a SQUARE transition effect ^{6,3}	
	Selects a CORNER transition effect ^{4,3}	
	Selects a CHESSBOARD transition effect ^{6,3}	
Picture	Separate keys for PREVIEW/PROGRAM Outputs	Adjusts the picture contrast, brightness, saturation, auto gain, and auto image
Freeze		Toggles the freeze function of the output video image
Blank		Toggles a blank screen
PIP		Toggles the picture-in-picture function
Save	Saves the setting	
Recall	Recalls the setting	
Navigation Keys	Consists of a set of 5 separate keys that allow maneuvering within an OSD screen	
Menu	Displays the OSD Menu screen (or moves to the previous level in the OSD menu)	
OSD	Activates/deactivates access to the OSD Menu	
Selector	8 separate selector keys for both the Program and the Preview outputs	

1 When "Off" the machine shuts down its outputs, disables the front panel, and causes the IR Receiver / LED to light red (instead of green)

2 The effect is only seen on the PROGRAM output

3 Only for setting up the unit for the effect. The effect will only occur when the Take button is pressed

4 Choose the direction from where the effect starts: "top left", "bottom left", "top right" or "bottom right" (see [Section 9.1.2](#))

5 Choose the direction from where the effect starts: "left to right", "right to left", "up" or "down" (see [Section 9.1.2](#))

6 Choose the direction from where the effect starts: "in" or "out" (see [Section 9.1.2](#))

9.4 Operating via the Ethernet

The control application lets you control the **VP-747** by clicking the desired buttons in the control application screen (which includes all the front panel buttons). To control the **VP-747** via the Ethernet/Serial Port:

1. Connect the Ethernet port (see [Section 7.4](#)) of the **VP-747** to the Ethernet port of your PC¹.
2. Install and configure the Control Application (see [Section 9.4.1](#)).

9.4.1 Installing and Running the Configuration Software

To install the **VP-747** Control Application, do the following:

1. Insert the product CD into your CD-ROM drive².
2. Save the zip file on your computer.
3. Run the installer setup.
4. Respond to the installation wizard prompts.

9.4.2 Configuring the Ethernet Connection

Double click the *VP747.exe* icon. The *VP747 Control Application* main screen appears (see [Figure 20](#)).

You can configure the Ethernet³ in any one of the following ways; via

- The Ethernet connection, using the Lantronix device software²
- The **VP-747** Device menu (the OSD) or via the Control Application menu: <Utility> <TCP/IP setting>, and then setting the IP Address, subnet mask and so on, and then clicking Apply
- RS-232 communication between the PC and the **VP-747**, and setting the IP Address through the Com port menu in the Control Application

1 Or connect the serial port of your VP-747 to the serial port of your PC (see [Section 7.1](#))

2 You can download the software from our Web site on <http://www.kramerelectronics.com>

3 The VP-747 communication port is 5000



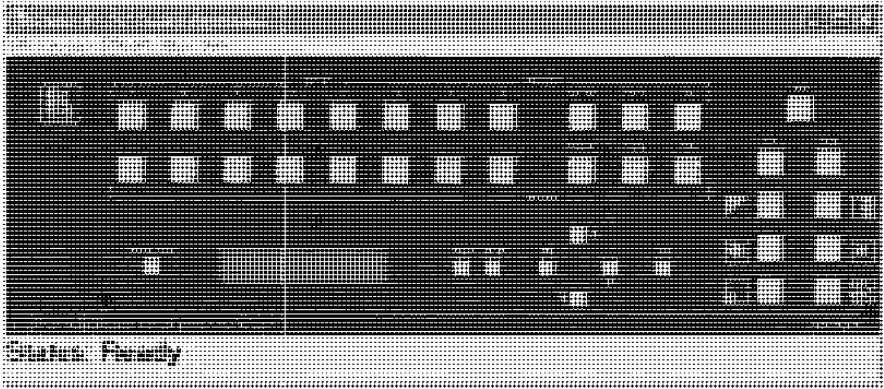

Figure 20: VP-747 Control Application Screen

Table 12 defines the menu items:

Table 12: VP-747 Control Application Menu

Menu	Items
File	Save Configuration, Exit
Com port	Select (the com port), Connect (to the selected com port)
Ethernet	Connect to the Ethernet
Menu	Menu options (enter the VP-747 menu, see Section 9.1)
Help	About

9.4.3 Control the VP-747 via the Ethernet/Serial Port

To control the VP-747 via the Ethernet/serial port click the buttons on the virtual VP-747 front panel and/or open the Menu item and use the OSD menus.

10 Technical Specifications

Table 13 includes the technical specifications:

Table 13: Technical Specifications¹ of the VP-747

INPUTS:	2 HDMI/DVI inputs connectors (HDMI version 1.2 and HDCP version 1.2) on DVI connectors 8 sets of universal BNC connectors: R/Pr, G/Y/CV, B/Pb/C, Hs/Cs, and Vs, each programmable for use as CV, YC, RGB, YCbCr, YPbPr, RGBS or RGBHV
PREVIEW OUTPUT:	1 x HDMI/DVI input connector (HDMI version 1.2 and HDCP version 1.2) on a DVI connector 1 x VGA (VGA through UXGA) on a 15-pin HD connector 1 x RGBHV / YPbPr on BNC connectors
PROGRAM OUTPUT:	1 x HDMI/DVI input connector (HDMI version 1.2 and HDCP version 1.2) on a DVI connector 1 x VGA (VGA through UXGA) on a 15-pin HD connector 1 x RGBHV / YPbPr on BNC connectors
OUTPUT RESOLUTIONS ² :	640x480 60Hz, 640x480 75Hz, 800x600 50Hz, 800x600 60Hz, 800x600 75Hz, 832x624 75Hz, 852x480 60Hz, 1024x768 50Hz, 1024x768 60Hz, 1024x768 75Hz, 1280x720 60Hz, 1280x768 50Hz, 1280x768 60Hz, 1280x800 60Hz, 1280x1024 50Hz, 1280x1024 60Hz, 1280x1024 75Hz, 1366x768 50Hz, 1366x768 60Hz, 1400x1050 50Hz, 1400x1050 60Hz, 1440x900 60Hz, 1600x1200 50Hz, 1600x1200 60Hz, 1680x1050 60Hz, 1920x1080 50Hz, 1920x1080 60Hz, 1920x1200 60Hz, 480p, 576p, 720p 50Hz, 720p 60Hz, 1080i 50Hz, 1080i 60Hz, 1080p 50Hz, 1080p 60Hz, 1080p 24Hz (for HDMI), or Custom ³
CONTROLS:	Front panel buttons, high contrast LCD, IR remote control, ETHERNET, AUDIO CONTROL, RS-232 and RS-485 for optional T-bar remote controller
ADDITIONAL CONTROLS:	Freeze, zoom, different selectable vertical refresh rates, ProcAmp control, output image scaling, Picture-In-Picture, and aspect ratio change
POWER SOURCE:	100-240 VAC, 50/60Hz 65VA
D MENSIONS:	19" (W), 9.3" (D), 3RU (H) rack mountable
WEIGHT:	5.5kg. (12.2lbs) approx.
ACCESSORIES:	IR remote control, power cord, null-modem adapter
OPTIONS:	Control panel

1 Specifications are subject to change without notice

2 For the most updated resolution list, go to our Web site at <http://www.kramerelectronics.com>

3 Up to four custom settings



11 VP-747 Communication Protocol

This section includes the Communication Protocol for the **VP-747**:
Communication Confirm:

```
Send CR
Reply CR>
```

Set Command

```
Send Y■Control_Type■Function■Param■CR
Reply Z■Control_Type■Function■Param■CR>
```

Get Command

```
Send Y■Control_Type■Function■CR
Reply Z■Control_Type■Function■Param■CR>
```

Example: set Preview Source Type of Current Channel = RGBHV

```
Send Y■0■43■0■CR
Reply Z■0■43■0■CR>
```

Example: get Preview Source Type of Current Channel

```
Send Y■1■43■CR
Reply Z■1■43■0■CR >
```

■: ASCII Code 0x20

CR : Ascii Code 0x0D

After set type Command setting, the system will respond with a string.

Baud rate: 9600/115200bps, Data Bit: 8Bit, Parity: None, and Stop Bit: 1Bit.

Table 14 defines the Set Commands:

Table 14: Set Commands¹

Control Type		Function	Param1	Param2	Param3	Param4	Description
Set	Get						
0	1	0	0:Off 1:On	-	-	-	Power
0	1	1	0:Off 1:On	-	-	-	Panel Lock
0	-	2	-	-	-	-	Take
0	-	3	-	-	-	-	Cut
0	-	4	-	-	-	-	Fade
0	-	5	-	-	-	-	Diagonal
0	-	6	-	-	-	-	Wipe
0	-	7	-	-	-	-	Circle
0	-	8	-	-	-	-	Square
0	-	9	-	-	-	-	Corner
0	-	10	-	-	-	-	Chessboard
0	-	11	-	-	-	-	Preview Picture
0	1	12	0:Off 1:On	-	-	-	Preview Freeze
0	1	13	0:Off 1:On	-	-	-	Preview Blank
0	-	14	-	-	-	-	Program Picture
0	1	15	0:Off 1:On	-	-	-	Program Freeze
0	1	16	0:Off 1:On	-	-	-	Program Blank
0	-	17	-	-	-	-	Up
0	-	18	-	-	-	-	Down
0	-	19	-	-	-	-	Left
0	-	20	-	-	-	-	Right
0	-	21	-	-	-	-	Menu
0	-	22	-	-	-	-	Enter
0	1	23	0: Off 1: On	-	-	-	OSD
0	1	41	0: Channel 1 1: Channel 2 2: Channel 3 3: Channel 4 4: Channel 5 5: Channel 6 6: Channel 7 7: Channel 8	-	-	-	Preview Input Source
0	1	42	0: RGBHV 1: RGBS(PC) 2: RGB(PC) 3: RGBS(Video) 4: RGB(Video) 5: YCbCr 6: Y/C 7: Video 8: HDMI	-	-	-	Preview Input Type HDMI can only be selected for Channel 1 or Channel 2
0	1	43	0: Auto 1: NTSC 2: PAL 3: PAL-M 4: PAL-N 5: NTSC 4.43 6: SECAM 7: PAL 60	-	-	-	Preview Input Video Standard

¹ F = Function

VP-747 Communication Protocol

Control Type		Function	Param1	Param2	Param3	Param4	Description
Set	Get						
0	1	44	1 ~ N	-	-	-	Preview Input Main Source H-Position N: unfixed, will change with Input Mode
0	1	45	2 ~ N	-	-	-	Preview Input Main Source V-Position N: unfixed, will change with Input Mode
0	1	46	-A ~ A	-	-	-	Preview Input Frequency A = (max - min)/2 min = 0, max = will change with input mode
0	1	47	0 ~ 31	-	-	-	Preview Input Phase (only for VGA Source)
0	-	48	-	-	-	-	Preview Auto Image
0	1	49	0: Off 1: On	-	-	-	Preview Over Scan Status
0	1	50	-50 ~ 50	-	-	-	Preview Picture Brightness
0	1	51	-50 ~ 50	-	-	-	Preview Picture Contrast
0	1	52	-50 ~ 50	-	-	-	Preview Picture Color
0	1	53	-180 ~ 180	-	-	-	Preview Picture Hue
0	1	54	-50 ~ 50	-	-	-	Preview Picture Sharpness
0	1	55	0: Gamma 1 1: Gamma 2 2: Gamma 3 3: Gamma 4 4: Gamma 5	-	-	-	Preview Picture Output Gamma
0	1	56	0: Auto 1: Video 2: Film	-	-	-	Preview Picture Film Mode
0	1	57	0: Off 1: Low 2: Medium 3: High	-	-	-	Preview Picture Temporal NR
0	1	58	0: Off 1: Low 2: Medium 3: High	-	-	-	Preview Picture Mosquito NR
0	1	59	0: Off 1: On	-	-	-	Preview Picture Block NR
0	1	60	0: Off 1: Low 2: Medium 3: High	-	-	-	Preview Picture Detail Enhancement
0	1	61	0: Off 1: Low 2: High	-	-	-	Preview Picture Luma Transition Enhance

VP-747 Communication Protocol

Control Type		Function	Param1	Param2	Param3	Param4	Description
Set	Get						
0	1	62	0: Off 1: Low 2: High	-	-	-	Preview Picture Chroma Transition Enhance
0	1	63	0: Best Fit 1: Letterbox 2: Follow Output 3: Virtual Wide 4: Follow Input 5: Custom	-	-	-	Preview Scale Aspect Ratio
0	1	64	-16 ~ 16	-	-	-	Preview Scale H-Pan
0	1	65	-16 ~ 16	-	-	-	Preview Scale V-Pan
0	1	66	-8 ~ 8	-	-	-	Preview Scale H-Zoom
0	1	67	-8 ~ 8	-	-	-	Preview Scale V-Zoom
0	1	68	0: Off 1: 150% 2: 200% 3: 225% 4: 250% 5: 275% 6: 300% 7: 325% 8: 350% 9: 375% 10: 400% 11: Custom	-	-	-	Preview Scale Zoom
0	1	69	0 ~ 32	-	-	-	Preview Scale Custom Zoom
0	1	70	-16 ~ 16	-	-	-	Preview Scale Zoom H-Pan
0	1	71	-16 ~ 16	-	-	-	Preview Scale Zoom V-Pan
0	1	72	0: Off 1: On	-	-	-	Preview P P On/Off
0	1	73	0: Picture-In-Picture 1: Picture + Picture 2: Split	-	-	-	Preview P P Type
0	1	74	0: Channel 1 1: Channel 2 2: Channel 3 3: Channel 4 4: Channel 5 5: Channel 6 6: Channel 7 7: Channel 8	-	-	-	Preview P P Source
0	1	75	0: 1/25 1: 1/16 2: 1/9 3: 1/4 4: Custom	-	-	-	Preview P P Size
0	1	76	0 ~ 128	-	-	-	Preview P P H-Position
0	1	77	0 ~ 128	-	-	-	Preview P P V-Position
0	1	78	1 ~ 255	-	-	-	Preview P P H-Size
0	1	79	1 ~ 255	-	-	-	Preview P P V-Size
0	1	80	0: Off 1: On	-	-	-	Preview P P Frame



VP-747 Communication Protocol

Control Type		Function	Param1	Param2	Param3	Param4	Description
Set	Get						
0	1	81	0 Red 1:Green 2 Blue	-	-	-	Preview P P Frame Color
0	1	82	0: 640x480 60Hz 1: 640x480 75Hz 2: 800x600 50Hz 3: 800x600 60Hz 4: 800x600 75Hz 5: 832x624 75Hz 6: 852x480 60Hz 7: 1024x768 50Hz 8: 1024x768 60Hz 9: 1024x768 75Hz 10: 1280x720 60Hz 11: 1280x768 50Hz 12: 1280x768 60Hz 13: 1280x800 60Hz 14: 1280x1024 50Hz 15: 1280x1024 60Hz 16: 1280x1024 75Hz 17: 1366x768 50Hz 18: 1366x768 60Hz 19: 1400x1050 50Hz 20: 1400x1050 60Hz 21: 1440x900 60Hz 22: 1600x1200 50Hz 23: 1600x1200 60Hz 24: 1680x1050 60Hz 25: 1920x1080 50Hz 26: 1920x1080 60Hz 27: 1920x1200 60Hz 28: 480p 29: 576p 30: 720p 50Hz 31: 720p 60Hz 32: 1080i 50Hz 33: 1080i 60Hz 34: 1080p 50Hz 35: 1080p 60Hz 36: 1080p 24Hz 37: Custom 1 38: Custom 2 39: Custom 3 40: Custom 4	-	-	-	Preview Output Resolution
0	1	83	-100 ~ 100	-	-	-	Preview Red Saturation
0	1	84	-100 ~ 100	-	-	-	Preview Green Saturation
0	1	85	-100 ~ 100	-	-	-	Preview Blue Saturation
0	1	86	-100 ~ 100	-	-	-	Preview Cyan Saturation
0	1	87	-100 ~ 100	-	-	-	Preview Magenta Saturation
0	1	88	-100 ~ 100	-	-	-	Preview Yellow Saturation
0	1	89	0: Custom 1 1: Custom 2 2: Custom 3 3: Custom 4	-	-	-	Preview Custom Input Target
0	1	90	512 ~ 3071	-	-	-	Preview Input Setting User Mode HT

VP-747 Communication Protocol

Control Type	Function	Param1	Param2	Param3	Param4	Description	
Set	Get						
0	1	91	32~(HS-48)	-	-	-	Preview Input Setting User Mode HWV
0	1	92	80~(HT-HA-12)	-	-	-	Preview Input Setting User Mode HS
0	1	93	640~1920 <= (HT-92)	-	-	-	Preview Input Setting User Mode HA
0	1	94	0: - 1: +	-	-	-	Preview Input Setting User Mode HP
0	1	95	384~2047	-	-	-	Preview Input Setting User Mode VT
0	1	96	2~(HS-13)	-	-	-	Preview Input Setting User Mode VW
0	1	97	15~(VT-VA-1)	-	-	-	Preview Input Setting User Mode VS
0	1	98	480~1200 <= (VT-16)	-	-	-	Preview Input Setting User Mode VA
0	1	99	0: - 1: +	-	-	-	Preview Input Setting User Mode VP
0	1	100	25 ~ 165 (Integer Value)	0 ~ 999 (Decimal Value)	-	-	Preview Input Setting User Mode OCLK
0	1	101	0:Off 1:On	-	-	-	Preview Input Setting Enable
0	-	102	-	-	-	-	Preview Input Setting User Mode Save
0	1	103	0: Custom 1 1: Custom 2 2: Custom 3 3: Custom 4	-	-	-	Preview Custom Output Target
0	1	104	512 ~ 3071	-	-	-	Preview Output Setting User Mode HT
0	1	105	32~(HS-48)	-	-	-	Preview Output Setting User Mode HWV
0	1	106	80~(HT-HA-12)	-	-	-	Preview Output Setting User Mode HS
0	1	107	640 ~ 1920	-	-	-	Preview Output Setting User Mode HA
0	1	108	0: - 1: +	-	-	-	Preview Output Setting User Mode HP
0	1	109	384~2047	-	-	-	Preview Output Setting User Mode VT
0	1	110	2~(HS-13)	-	-	-	Preview Output Setting User Mode VW
0	1	111	15~(VT-VA-1)	-	-	-	Preview Output Setting User Mode VS



VP-747 Communication Protocol

Control Type		Function	Param1	Param2	Param3	Param4	Description
Set	Get						
0	1	112	480 ~ 1200	-	-	-	Preview Output Setting User Mode VA
0	1	113	0: - 1: +	-	-	-	Preview Output Setting User Mode VP
0	1	114	25 ~ 165 (Integer Value)	0 ~ 999 (Decimal Value)	-	-	Preview Output Setting User Mode OCLK
0	-	115	-	-	-	-	Preview Output Setting User Mode Save
0	-	116	-	-	-	-	Preview Output Setting User Mode Set Current
0	1	117	0 Keystone 1 Anyplace 2 Rotation	-	-	-	Preview Geometry Application
0	1	118	0: Front 1: Ceiling 2: Rear 3: Rear Ceiling	-	-	-	Preview Geometry Location
0	1	119	-40 ~ 40	-	-	-	Preview Geometry H-Keystone
0	1	120	-30 ~ 30	-	-	-	Preview Geometry V-Keystone
0	1	121	0: Top Left 1: Top Right 2: Bottom Left 3: Bottom Right	0: Horizontal 1: vertical	-2000 ~ 2000	-	Preview Geometry Diagonal Projection
0	-	122	-	-	-	-	Preview Geometry Diagonal Projection Reset
0	1	123	-20 ~ 20	-	-	-	Preview Geometry Pincushion/Barrel
0	1	124	-180 ~ 180	-	-	-	Preview Geometry Rotation
0	-	125	-	-	-	-	Preview Geometry Reset all
0	1	151	0: Channel 1 1: Channel 2 2: Channel 3 3: Channel 4 4: Channel 5 5: Channel 6 6: Channel 7 7: Channel 8	-	-	-	Program Input Source
0	1	152	0: RGBHV 1: RGBS(PC) 2: RGB(PC) 3: RGBS(Video) 4: RGB(Video) 5: YCbCr 6: Y/C 7: Video 8: HDMI	-	-	-	Program Input Type HDMI can only be selected for Channel 1 or Channel 2

VP-747 Communication Protocol

Control Type		Function	Param1	Param2	Param3	Param4	Description
Set	Get						
0	1	153	0: Auto 1: NTSC 2: PAL 3: PAL-M 4: PAL-N 5: NTSC 4.43 6: SECAM 7: PAL 60	-	-	-	Program Input Video Standard
0	1	154	1 ~ N	-	-	-	Program Input Main Source H-Position N: unfixed, will change with Input Mode
0	1	155	2 ~ N	-	-	-	Program Input Main Source V-Position N: unfixed, will change with Input Mode
0	1	156	-A ~ A	-	-	-	Program Input Frequency A = (max - min)/2 min = 0, max = will change with input mode
0	1	157	0 ~ 31	-	-	-	Program Input Phase (only for VGA Source)
0	-	158	-	-	-	-	Program Auto Image
0	1	159	0: Off 1: On	-	-	-	Program Over Scan Status
0	1	160	-50 ~ 50	-	-	-	Program Picture Brightness
0	1	161	-50 ~ 50	-	-	-	Program Picture Contrast
0	1	162	-50 ~ 50	-	-	-	Program Picture Color
0	1	163	-180 ~ 180	-	-	-	Program Picture Hue
0	1	164	-50 ~ 50	-	-	-	Program Picture Sharpness
0	1	165	0: Gamma 1 1: Gamma 2 2: Gamma 3 3: Gamma 4 4: Gamma 5	-	-	-	Program Picture Output Gamma
0	1	166	0: Auto 1: Video 2: Film	-	-	-	Program Picture Film Mode
0	1	167	0: Off 1: Low 2: Medium 3: High	-	-	-	Program Picture Temporal NR
0	1	168	0: Off 1: Low 2: Medium 3: High	-	-	-	Program Picture Mosquito NR
0	1	169	0: Off 1: On	-	-	-	Program Picture Block NR



VP-747 Communication Protocol

Control Type		Function	Param1	Param2	Param3	Param4	Description
Set	Get						
0	1	170	0: Off 1: Low 2: Medium 3: High	-	-	-	Program Picture Detail Enhancement
0	1	171	0: Off 1: Low 2: High	-	-	-	Program Picture Luma Transition Enhance
0	1	172	0: Off 1: Low 2: High	-	-	-	Program Picture Chroma Transition Enhance
0	1	173	0: Best Fit 1: Letterbox 2: Follow Output 3: Virtual Wide 4: Follow Input 5: Custom	-	-	-	Program Scale Aspect Ratio
0	1	174	-16 ~ 16	-	-	-	Program Scale H-Pan
0	1	175	-16 ~ 16	-	-	-	Program Scale V-Pan
0	1	176	-8 ~ 8	-	-	-	Program Scale H-Zoom
0	1	177	-8 ~ 8	-	-	-	Program Scale V-Zoom
0	1	178	0: Off 1: 150% 2: 200% 3: 225% 4: 250% 5: 275% 6: 300% 7: 325% 8: 350% 9: 375% 10: 400% 11: Custom	-	-	-	Program Scale Zoom
0	1	179	0 ~ 32	-	-	-	Program Scale Custom Zoom
0	1	180	-16 ~ 16	-	-	-	Program Scale Zoom H-Pan
0	1	181	-16 ~ 16	-	-	-	Program Scale Zoom V-Pan
0	1	182	0: Off 1: On	-	-	-	Program PIP On/Off
0	1	183	0: Picture-In-Picture 1: Picture + Picture 2: Split	-	-	-	Program PIP Type
0	1	184	0: Channel 1 1: Channel 2 2: Channel 3 3: Channel 4 4: Channel 5 5: Channel 6 6: Channel 7 7: Channel 8	-	-	-	Program PIP Source
0	1	185	0: 1/25 1: 1/16 2: 1/9 3: 1/4 4: Custom	-	-	-	Program PIP Size
0	1	186	0 ~ 128	-	-	-	Program PIP H-Position

VP-747 Communication Protocol

Control Type		Function	Param1	Param2	Param3	Param4	Description
Set	Get						
0	1	187	0 ~ 128	-	-	-	Program PIP V-Position
0	1	188	1 ~ 255	-	-	-	Program PIP H-Size
0	1	189	1 ~ 255	-	-	-	Program PIP V-Size
0	1	200	0: Off 1: On	-	-	-	Program PIP Frame
0	1	201	0 Red 1: Green 2 Blue	-	-	-	Program PIP Frame Color
0	1	202	0: 640x480 60Hz 1: 640x480 75Hz 2: 800x600 50Hz 3: 800x600 60Hz 4: 800x600 75Hz 5: 832x624 75Hz 6: 852x480 60Hz 7: 1024x768 50Hz 8: 1024x768 60Hz 9: 1024x768 75Hz 10: 1280x720 60Hz 11: 1280x768 50Hz 12: 1280x768 60Hz 13: 1280x800 60Hz 14: 1280x1024 50Hz 15: 1280x1024 60Hz 16: 1280x1024 75Hz 17: 1366x768 50Hz 18: 1366x768 60Hz 19: 1400x1050 50Hz 20: 1400x1050 60Hz 21: 1440x900 60Hz 22: 1600x1200 50Hz 23: 1600x1200 60Hz 24: 1680x1050 60Hz 25: 1920x1080 50Hz 26: 1920x1080 60Hz 27: 1920x1200 60Hz 28: 480p 29: 576p 30: 720p 50Hz 31: 720p 60Hz 32: 1080i 50Hz 33: 1080i 60Hz 34: 1080p 50Hz 35: 1080p 60Hz 36: 1080p 24Hz 37: Custom 1 38: Custom 2 39: Custom 3 40: Custom 4	-	-	-	Program Output Resolution
0	1	203	-100 ~ 100	-	-	-	Program Red Saturation
0	1	204	-100 ~ 100	-	-	-	Program Green Saturation
0	1	205	-100 ~ 100	-	-	-	Program Blue Saturation
0	1	206	-100 ~ 100	-	-	-	Program Cyan Saturation
0	1	207	-100 ~ 100	-	-	-	Program Magenta Saturation



VP-747 Communication Protocol

Control Type		Function	Param1	Param2	Param3	Param4	Description
Set	Get						
0	1	208	-100 ~ 100	-	-	-	Program Yellow Saturation
0	1	209	0: Custom 1 1: Custom 2 2: Custom 3 3: Custom 4	-	-	-	Program Custom Input Target
0	1	210	512~3071	-	-	-	Program Input Setting User Mode HT
0	1	211	32~(HS-48)	-	-	-	Program Input Setting User Mode HW
0	1	212	80~(HT-HA-12)	-	-	-	Program Input Setting User Mode HS
0	1	213	640~1920 <= (HT-92)	-	-	-	Program Input Setting User Mode HA
0	1	214	0: - 1: +	-	-	-	Program Input Setting User Mode HP
0	1	215	384~2047	-	-	-	Program Input Setting User Mode VT
0	1	216	2~(HS-13)	-	-	-	Program Input Setting User Mode VW
0	1	217	15~(VT-VA-1)	-	-	-	Program Input Setting User Mode VS
0	1	218	480~1200 <= (VT-16)	-	-	-	Program Input Setting User Mode VA
0	1	219	0: - 1: +	-	-	-	Program Input Setting User Mode VP
0	1	220	25 ~ 165 (Integer Value)	0 ~ 999 (Decimal Value)	-	-	Program Input Setting User Mode OCLK
0	1	221	0: Off 1: On	-	-	-	Program Input Setting Enable
0	-	222	-	-	-	-	Program Input Setting User Mode Save
0	1	223	0: Custom 1 1: Custom 2 2: Custom 3 3: Custom 4	-	-	-	Program Custom Output Target
0	1	224	512~3071	-	-	-	Program Output Setting User Mode HT
0	1	225	32~(HS-48)	-	-	-	Program Output Setting User Mode HW
0	1	226	80~(HT-HA-12)	-	-	-	Program Output Setting User Mode HS
0	1	227	640~1920 <= (HT-92)	-	-	-	Program Output Setting User Mode HA
0	1	228	0: - 1: +	-	-	-	Program Output Setting User Mode HP

VP-747 Communication Protocol

Control Type		Function	Param1	Param2	Param3	Param4	Description
Set	Get						
0	1	229	384~2047	-	-	-	Program Output Setting User Mode VT
0	1	230	2~(HS-13)	-	-	-	Program Output Setting User Mode VW
0	1	231	15~(VT-VA-1)	-	-	-	Program Output Setting User Mode VS
0	1	232	480~1200 <= (VT-16)	-	-	-	Program Output Setting User Mode VA
0	1	233	0: - 1: +	-	-	-	Program Output Setting User Mode VP
0	1	234	25 ~ 165 (Integer Value)	0 ~ 999 (Decimal Value)	-	-	Program Output Setting User Mode OCLK
0	-	235	-	-	-	-	Program Output Setting User Mode Save
0	-	236	-	-	-	-	Program Output Setting User Mode Set Current
0	1	237	0 Keystone 1 Anyplace 2 Rotation	-	-	-	Program Geometry Application
0	1	238	0: Front 1: Ceiling 2: Rear 3: Rear_Ceiling	-	-	-	Program Geometry Location
0	1	239	-40 ~ 40	-	-	-	Program Geometry H-Keystone
0	1	240	-30 ~ 30	-	-	-	Program Geometry V-Keystone
0	1	241	0: Top Left 1: Top Right 2: Bottom Left 3: Bottom Right	0:H 1:V	-2000 ~ 2000	-	Program Geometry Diagonal Projection
0	-	242	-	-	-	-	Program Geometry Diagonal Projection Reset
0	1	243	-20 ~ 20	-	-	-	Program Geometry Pincushion/Barrel
0	1	244	-180 ~ 180	-	-	-	Program Geometry Rotation
0	-	245	-	-	-	-	Program Geometry Reset all
0	1	271	0: Cut 1: Fade 2: Diagonal 3: Wipe 4: Circle 5: Square 6: Corner 7: Chessboard	-	-	-	Transition Effect



VP-747 Communication Protocol

Control Type		Function	Param1	Param2	Param3	Param4	Description
Set	Get						
0	1	272	0: Swap 1: Follow	-	-	-	Transition Mode
0	1	273	1 ~ 5	-	-	-	Transition Speed
0	1	274	0 = no damping 1 = damping with a maximum jump size of 10 steps 2 = damping with a maximum jump size of 5 steps 3 = damping with a maximum jump size of 3 steps 4 = damping with a maximum jump size of 2 steps	-	-	-	Transition Damping
0	1	275	0: Top left 1: Bottom left 2: Top right 3: Bottom right	-	-	-	Transition Effect Option - Diagonal
0	1	276	0: Left to right 1: Right to left 2: Up 3: Down	-	-	-	Transition Effect Option - Wipe
0	1	277	0: In 1: Out	-	-	-	Transition Effect Option - Circle
0	1	278	0: In 1: Out	-	-	-	Transition Effect Option - Square
0	1	279	0: Top left 1: Bottom left 2: Top right 3: Bottom right	-	-	-	Transition Effect Option - Corner
0	1	280	0: In 1: Out	-	-	-	Transition Effect Option - Chessboard
0	-	281	-	-	-	-	Transition Take
0	1	286	0: Channel 1 1: Channel 2 2: Channel 3 3: Channel 4 4: Channel 5 5: Channel 6 6: Channel 7 7: Channel 8	-	-	-	Audio Program Input source
0	1	287	-82 ~ 45	-	-	-	Audio Program Input Volume, -82 = Mute
0	1	288	-22 ~ 9	-	-	-	Audio Program Output Volume, -22 = Mute
0	1	289	0 ~ 127	-	-	-	Audio Program Input Delay
0	1	290	0: Channel 1 1: Channel 2 2: Channel 3 3: Channel 4 4: Channel 5 5: Channel 6 6: Channel 7 7: Channel 8	-	-	-	Audio Preview input source
0	1	291	-82 ~ 45	-	-	-	Audio Preview Input Volume, -82 = Mute
0	1	292	-82 ~ 45	-	-	-	Audio Preview Output Volume, -82 = Mute

VP-747 Communication Protocol

Control Type		Function	Param1	Param2	Param3	Param4	Description
Set	Get						
0	1	293	0: Preview 1: Program	-	-	-	Audio headphone source
0	1	294	-12 ~ 4	-	-	-	Audio Headphone Volume, -12 = Mute
0	1	295	-6 ~ 6	-	-	-	Audio Bass
0	1	296	-6 ~ 6	-	-	-	Audio Treble0
0	1	297	-10 ~ 10	-	-	-	Audio Balance
-	1	298	0~32767 1->ON, 0->OFF bit 0: Chessboard bit 1: Panel lock bit 2: Menu bit 3: Enter bit 4: Left bit 5: Up bit 6: Down bit 7: Right bit 8: OSD	0~32767 1->ON, 0->OFF bit 0: Program Channel 8 bit 1: Preview Freeze bit 2: Program Freeze bit 3: Preview Blank bit 4: Program Blank bit 5: Preview PIP bit 6: Program PIP bit 7: Take bit 8: Cut bit 9: Diagonal bit 10: Circle bit 11: Corner bit 12: Fade bit 13: Wipe bit 14: Square	0~32767 1-> ON, 0->OFF bit 0: Preview Channel 1 bit 1: Program Channel 1 bit 2: Preview Channel 2 bit 3: Program Channel 2 bit 4: Preview Channel 3 bit 5: Program Channel 3 bit 6: Preview Channel 4 bit 7: Program Channel 4 bit 8: Preview Channel 5 bit 9: Program Channel 5 bit 10: Preview Channel 6 bit 11: Program Channel 6 bit 12: Preview Channel 7 bit 13: Program Channel 7 bit 14: Preview Channel 8	-	Keypad LED status
0	1	299	0: Audio Folow Video 1: Audio Breakaway	-	-	-	Audio Follow Video or Audio Breakaway
0	1	300	0: Off 1: On	-	-	-	Audio Fade
0	1	301	0 None 1 Freeze 2 Blank 3 Freeze&Blank	-	-	-	Audio Mute- Follow
0	-	302	-	-	-	-	Audio TAKE
0	1	306	0: Off 1: On	-	-	-	TCPIP DHCP
0	1	307	0 ~ 255	0 ~ 255	0 ~ 255	0 ~ 255	TCPIP P Address
0	1	308	0 ~ 255	0 ~ 255	0 ~ 255	0 ~ 255	TCPIP Subnet Mask
0	1	309	0 ~ 255	0 ~ 255	0 ~ 255	0 ~ 255	TCPIP Gateway
0	-	310	-	-	-	-	TCPIP Apply
0	1	311	0: Center 1: Top Left 2: Top Right 3: Bottom Left 4: Bottom Right	-	-	-	OSD Setting Menu Position
0	1	312	0: 5 second 1: 10 second 2: 20 second 3: 30 second 4: 60 second 5: 90 second 6: off	-	-	-	OSD Setting TimeOut



VP-747 Communication Protocol

Control Type		Function	Param1	Param2	Param3	Param4	Description
Set	Get						
0	1	313	0: Off 1: On (Kramer)	-	-	-	Misc Setting Logo
0	1	314	0: Off 1: On	-	-	-	Misc Setting Save Lock
0	1	315	0: Off 1: On	-	-	-	Misc Setting Input Lock
0	1	316	0 Blank 1 Blue 2 Disable Analog Sync	-	-	-	Misc Setting Background
0	1	317	0: Black 1: Blue	-	-	-	Misc Setting Blank Color
0	1	318	0: Off 1: On	-	-	-	Misc Setting Event Mode
0	1	319	0: 9600 1: 115200	-	-	-	Misc Setting Baudrate
0	1	320	0: Follow Output 1: Follow Input	-	-	-	Misc Setting HDCP Setting
0	-	321	0: Profile 1 1: Profile 2 2: Profile 3 3: Profile 4 4: Profile 5 5: Profile 6 6: Profile 7 7: Profile 8	-	-	-	Save
0	-	322	0: Profile 1 1: Profile 2 2: Profile 3 3: Profile 4 4: Profile 5 5: Profile 6 6: Profile 7 7: Profile 8	-	-	-	Recall
0	-	323	0: Profile 1 1: Profile 2 2: Profile 3 3: Profile 4 4: Profile 5 5: Profile 6 6: Profile 7 7: Profile 8 8: All	-	-	-	Erase
0	-	324	-	-	-	-	Factory Reset
0	1	325	0 Mode1 1400x1050@60HZ 1 Mode1 1680x1050@60HZ	-	-	-	Mode Set Mode1
0	1	326	0 Mode2 1280x1024@75HZ 1 Mode2 1280x1024@76HZ	-	-	-	Mode Set Mode2
0	1	327	0 Mode3 1280x768@60HZ 1 Mode3 1366x768@60HZ	-	-	-	Mode Set Mode3
0	1	328	0 Manual (Default) 1 Auto	-	-	-	Auto Image Mode

LIMITED WARRANTY

Kramer Electronics (hereafter *Kramer*) warrants this product free from defects in material and workmanship under the following terms.

HOW LONG IS THE WARRANTY

Labor and parts are warranted for seven years from the date of the first customer purchase.

WHO IS PROTECTED?

Only the first purchase customer may enforce this warranty.

WHAT IS COVERED AND WHAT IS NOT COVERED

Except as below, this warranty covers all defects in material or workmanship in this product. The following are not covered by the warranty:

1. Any product which is not distributed by Kramer, or which is not purchased from an authorized Kramer dealer. If you are uncertain as to whether a dealer is authorized, please contact Kramer at one of the agents listed in the Web site www.kramerelectronics.com.
2. Any product, on which the serial number has been defaced, modified or removed, or on which the WARRANTY VOID IF TAMPERED sticker has been torn, reattached, removed or otherwise interfered with.
3. Damage, deterioration or malfunction resulting from:
 - i) Accident, misuse, abuse, neglect, fire, water, lightning or other acts of nature
 - ii) Product modification, or failure to follow instructions supplied with the product
 - iii) Repair or attempted repair by anyone not authorized by Kramer
 - iv) Any shipment of the product (claims must be presented to the carrier)
 - v) Removal or installation of the product
 - vi) Any other cause, which does not relate to a product defect
 - vii) Cartons, equipment enclosures, cables or accessories used in conjunction with the product

WHAT WE WILL PAY FOR AND WHAT WE WILL NOT PAY FOR

We will pay labor and material expenses for covered items. We will not pay for the following:

1. Removal or installation charges.
2. Costs of initial technical adjustments (set-up), including adjustment of user controls or programming. These costs are the responsibility of the Kramer dealer from whom the product was purchased.
3. Shipping charges.

HOW YOU CAN GET WARRANTY SERVICE

1. To obtain service on your product, you must take or ship it prepaid to any authorized Kramer service center.
2. Whenever warranty service is required, the original dated invoice (or a copy) must be presented as proof of warranty coverage, and should be included in any shipment of the product. Please also include in any mailing a contact name, company, address, and a description of the problem(s).
3. For the name of the nearest Kramer authorized service center, consult your authorized dealer.

LIMITATION OF IMPLIED WARRANTIES

All implied warranties, including warranties of merchantability and fitness for a particular purpose, are limited in duration to the length of this warranty.

EXCLUSION OF DAMAGES

The liability of Kramer for any effective products is limited to the repair or replacement of the product at our option. Kramer shall not be liable for:

1. Damage to other property caused by defects in this product, damages based upon inconvenience, loss of use of the product, loss of time, commercial loss; or:
2. Any other damages, whether incidental, consequential or otherwise. Some countries may not allow limitations on how long an implied warranty lasts and/or do not allow the exclusion or limitation of incidental or consequential damages, so the above limitations and exclusions may not apply to you.

This warranty gives you specific legal rights, and you may also have other rights, which vary from place to place.

NOTE: All products returned to Kramer for service must have prior approval. This may be obtained from your dealer.

This equipment has been tested to determine compliance with the requirements of:

- EN-50081: "Electromagnetic compatibility (EMC);
generic emission standard.
Part 1: Residential, commercial and light industry"
- EN-50082: "Electromagnetic compatibility (EMC) generic immunity standard.
Part 1: Residential, commercial and light industry environment".
- CFR-47: FCC* Rules and Regulations:
Part 15: "Radio frequency devices
Subpart B Unintentional radiators"

CAUTION!

- Servicing the machines can only be done by an authorized Kramer technician. Any user who makes changes or modifications to the unit without the expressed approval of the manufacturer will void user authority to operate the equipment.
- Use the supplied DC power supply to feed power to the machine.
- Please use recommended interconnection cables to connect the machine to other components.
* FCC and CE approved using STP cable (for twisted pair products)



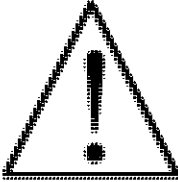

For the latest information on our products and a list of Kramer distributors, visit our Web site: www.kramerelectronics.com, where updates to this user manual may be found. We welcome your questions, comments and feedback.

 <p>Caution</p>	<p>Safety Warning Equipment has built-in safety features. Personal safety features operate automatically.</p>
---	--

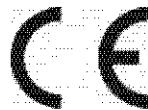

Kramer Electronics, Ltd.
Web site: www.kramerelectronics.com
E-mail: info@kramere1.com
P/N: 2900-000563 REV 1