

Kramer Electronics, Ltd.

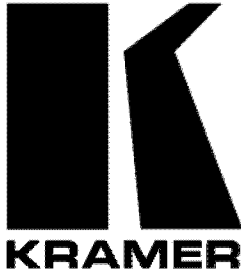

USER MANUAL

Models:

6410, *Digital to Analog Audio Converter*

6420, *Analog to Digital Audio Converter*

Contents

1	Introduction	1
2	Getting Started	1
3	Overview	1
3.1	Digital Audio Inputs/Outputs on the 6410 and 6420	2
3.2	About the 6410 Digital to Analog Audio Converter	2
3.3	About the 6420 Analog to Digital Audio Converter	3
3.4	High Signal Quality Recommendations	3
4	Your Audio Converters	3
4.1	Defining the 6410 Digital to Analog Audio Converter	4
4.2	Defining the 6420 Analog to Digital Audio Converter	5
5	Using the Audio Converters	5
5.1	Connecting the 6410 Digital to Analog Audio Converter	6
5.1.1	Using the INPUT SELECTOR Switches	7
5.2	Connecting the 6420 Analog to Digital Audio Converter	7
5.2.1	Setting the MODE SELECTOR Dipswitches	8
6	Technical Specifications	9

Figures

Figure 1:	Digital Audio (Professional and Consumer) Inputs/Outputs on the 6410 / 6420	2
Figure 2:	6410 Digital to Analog Audio Converter	4
Figure 3:	6420 Analog to Digital Audio Converter	5
Figure 4:	Connecting the 6410 Digital to Analog Audio Converter	6
Figure 5:	Connecting the 6420 Analog to Digital Audio Converter	8
Figure 6:	6420 MODE SELECTOR Dipswitches	8

Tables

Table 1:	6410 Digital to Analog Audio Converter Features	4
Table 2:	6420 Analog to Digital Audio Converter Features	5
Table 3:	6410 Digital to Analog Audio Converter Technical Specifications	9
Table 4:	6420 Analog to Digital Audio Converter Technical Specifications	9

1 Introduction

Dedication by Kramer Electronics since 1981, to the development and manufacture of high quality video/audio equipment, makes the Kramer line an integral part of the finest production and presentation facilities in the world. In recent years, Kramer has redesigned and upgraded most of the line, making the best even better! The Kramer line of professional video/audio electronics is one of the most versatile and complete available, and is a true leader in terms of quality, workmanship, price/performance ratio and innovation. In addition to our high quality Kramer DigiTOOLS, like the **6410** *Digital to Analog Audio Converter* and **6420** *Analog to Digital Audio Converter*, we also offer excellent distribution amplifiers, switchers and matrices, remote controllers, processors, interfaces and computer-related products.

Congratulations on purchasing your Kramer **6410** *Digital to Analog Audio Converter* and/or **6420** *Analog to Digital Audio Converter*. These products are ideal for computer-based presentations and their compact size makes them convenient for professional recording studios.

The package includes the following items:

- **6410** *Digital to Analog Audio Converter* and/or **6420** *Analog to Digital Audio Converter*
- Power adapter(s)
- This user manual
- Kramer concise product catalog/CD

2 Getting Started

We recommend that you:

- Unpack the equipment carefully and save the original box and packaging materials for possible future shipment
- Review the contents of this user manual

3 Overview

Both the **6410** *Digital to Analog Audio Converter* and the **6420** *Analog to Digital Audio Converter* use digital audio transmission standards, as section 3.1 describes.

Sections 3.2 and 3.3 describe the **6410** *Digital to Analog Audio Converter* and the **6420** *Analog to Digital Audio Converter*, respectively.

3.1 Digital Audio Inputs/Outputs on the 6410 and 6420

Figure 1 illustrates the transmission standards for professional and consumer formats, which can be translated via the 6410/6420.

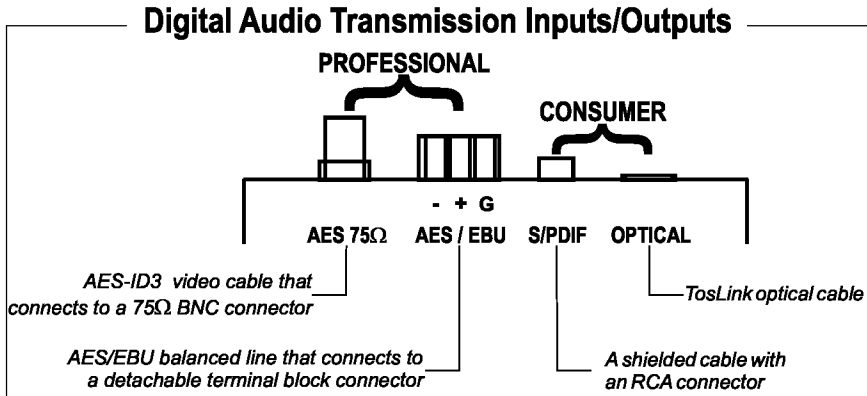

Figure 1: Digital Audio (Professional and Consumer) Inputs/Outputs on the 6410 / 6420

3.2 About the 6410 Digital to Analog Audio Converter

The multi-standard 6410 *Digital to Analog Audio Converter* accepts all serial digital audio transmission standards – AES/EBU, AES-ID3, S/PDIF and TosLink optical.

After conversion, the 6410 simultaneously¹ outputs:

- Analog balanced stereo on detachable terminal block connectors
- Unbalanced stereo on a 3.5" jack, capable of driving a 30 Ω load (headphones)

In particular, the 6410:

- Is adjustment-free
- Provides automatic equalization (it is cable-equalized) and reclocking of the digital audio stream coming from any digital input
- Has AES/EBU and AES-ID3 transformer coupled inputs
- Supports multi-standards - AES/EBU, IEC 958, S/PDIF and EIAJ CP340/1201 professional and consumer formats with sampling frequencies up to 48 kHz
- Has a conversion ratio of 0dbFS to +12dB

¹ As Figure 4 illustrates, the sound outputs from both the amplifier and the headphones simultaneously

3.3 About the 6420 Analog to Digital Audio Converter

The multi-standard **6420** *Analog to Digital Audio Converter* accepts analog balanced stereo audio on detachable terminal block connectors and converts and outputs it to the most commonly-used serial digital audio standards – AES/EBU, AES-ID3, S/PDIF and TosLink optical.

In particular, the **6420**:

- With its analog balanced stereo audio input signal, splits to 4 digital audio output signals¹, each conforming to a different standard
- Has AES/EBU and AES-ID3 transformer coupled outputs
- Supports multi-standards - AES/EBU, IEC 958, S/PDIF and EIAJ CP340/1201 professional and consumer formats with sampling frequencies up to 48 kHz
- Includes a set of 4 dipswitches for setting the system format bit (professional or consumer) and the sampling frequency (32k, 44.1k or 48k)
- Has a conversion ratio of -12dB to 0dbFS

3.4 High Signal Quality Recommendations

Achieving the best performance means:

- Connecting only good quality connection cables, thus avoiding interference, deterioration in signal quality due to poor matching, and elevated noise levels (often associated with low quality cables)
- Avoiding interference from neighboring electrical appliances that may adversely influence signal quality
- Positioning your Kramer **6410** and/or **6420** in a location free from moisture and away from excessive sunlight and dust

4 Your Audio Converters

Sections 4.1 and 4.2 define the **6410** *Digital to Analog Audio Converter* and the **6420** *Analog to Digital Audio Converter*, respectively.

¹ Functioning as a 1:4 DA

4.1 Defining the 6410 Digital to Analog Audio Converter

Figure 2 and Table 1 define the **6410 Digital to Analog Audio Converter**:

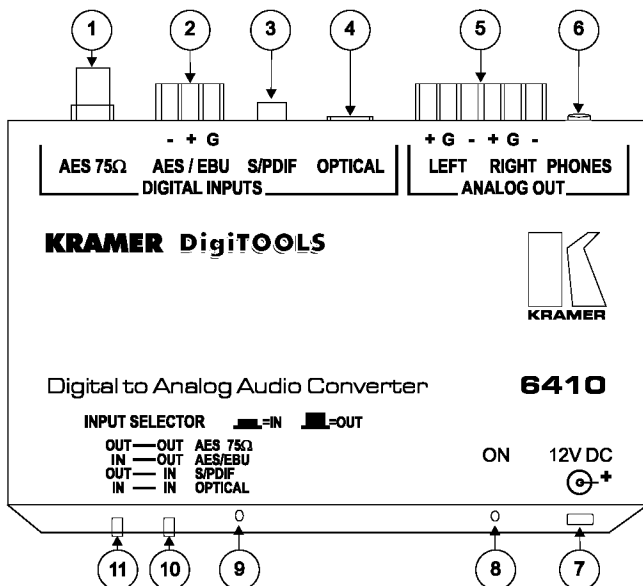

Figure 2: 6410 Digital to Analog Audio Converter

Table 1: 6410 Digital to Analog Audio Converter Features

#	Feature	Function
1	AES 75Ω BNC connector	Connects to the digital audio source (75Ω)
2	AES / EBU Detachable Terminal Block Connector	Connects to the digital audio source
3	S/PDIF RCA Connector	Connects to the digital audio source
4	OPTICAL Connector	Connects to the digital audio source ¹
5	LEFT and RIGHT Detachable Terminal Block Connectors	Connects to the analog audio acceptor
6	PHONES Out connector	Connects to a headphone set
7	12V DC	+12V DC connector for powering the unit
8	ON LED	Illuminates when receiving power
9	INPUT SELECTOR LED	Illuminates when receiving the appropriate input signal
10	INPUT SELECTOR Switch	OUT AES 75Ω and AES/EBU IN S/PDIF and OPTICAL
11	INPUT SELECTOR Switch	OUT AES 75Ω and S/PDIF IN AES/EBU and OPTICAL

¹ Use an optical cable, such as Sony's POC-15A (not included in the package)

4.2 Defining the 6420 Analog to Digital Audio Converter

Figure 3 and Table 2 define the **6420 Analog to Digital Audio Converter**:

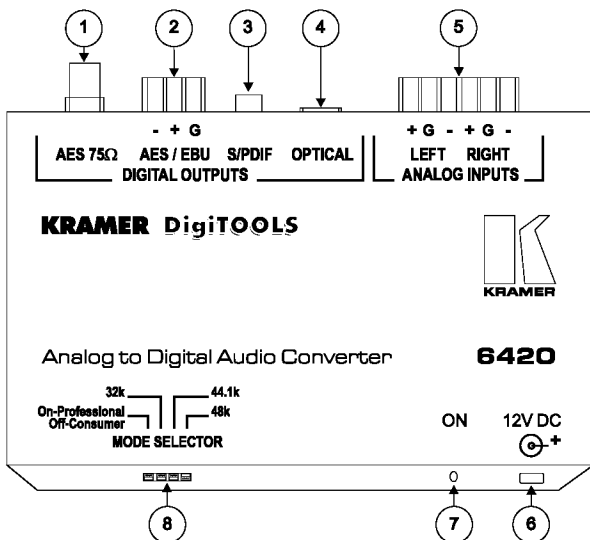

Figure 3: 6420 Analog to Digital Audio Converter

Table 2: 6420 Analog to Digital Audio Converter Features

#	Feature	Function
1	AES 75Ω BNC connector	Connects to the digital audio acceptor (75Ω)
2	AES / EBU Detachable Terminal Block Connector	Connects to the digital audio acceptor
3	S/PDIF RCA connector	Connects to the digital audio acceptor
4	OPTICAL connector	Connects to the digital audio acceptor ¹
5	LEFT and RIGHT ANALOG INPUTS Detachable Terminal Block Connectors	Connects to the analog audio source
6	12V DC	+12V DC connector for powering the unit
7	ON LED	Illuminates when receiving power
8	MODE SELECTOR Dipswitches	Set to choose the digital audio standard format (professional or consumer) and the appropriate digital sampling frequency, as section 5.2.1 describes

5 Using the Audio Converters

Sections 5.1 and 5.2 describe how to connect the **6410 Digital to Analog Audio Converter** and the **6420 Analog to Digital Audio Converter**, respectively.

¹ Use an optical cable, such as Sony's POC-15A (not included in the package)

5.1 Connecting the 6410 Digital to Analog Audio Converter

To connect your **6410 Digital to Analog Audio Converter**, as the example in Figure 4 illustrates, do the following:

1. Connect up to 4 sources to the 4 digital input connectors, as follows:
 - Connect an AES-75Ω source (for example, a DAT-Player) to the AES-75Ω BNC input connector
 - Connect an AES/EBU source (for example, a DAT-Player) to the AES/EBU detachable terminal block input connector using a shielded twisted pair cable
 - Connect a S/PDIF source (for example, a DVD Player) to the S/PDIF RCA input connector
 - Connect an optical source (for example, a CD Player) to the optical input connector
2. Connect the **6410** up to 2 analog acceptors, as follows:
 - Connect the left and right detachable terminal block output connectors via shielded twisted pair cables to an analog balanced stereo acceptor (for example, an amplifier with a pair of loud speakers)
 - Connect the PHONES 3.5mm output jack to a headphone set
3. Connect the 12V DC power adapter to the power socket and connect the adapter to the mains electricity.

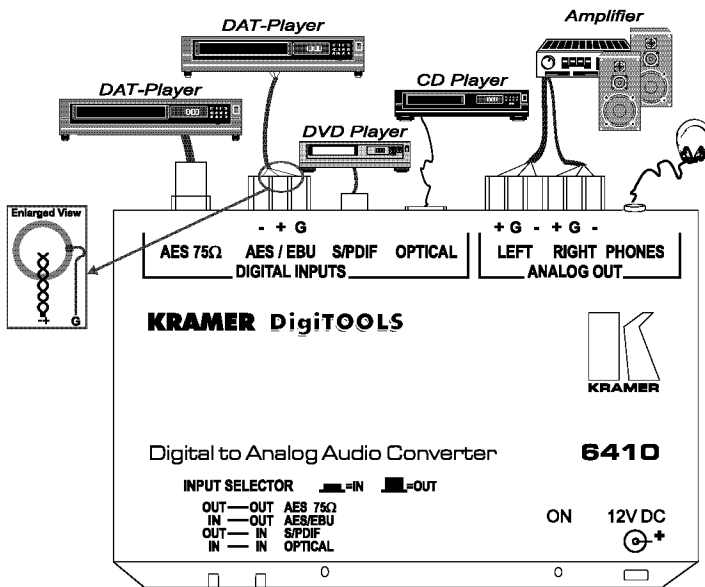

Figure 4: Connecting the 6410 Digital to Analog Audio Converter

5.1.1 Using the INPUT SELECTOR Switches

Set the digital input standard by pushing in and/or releasing one or both of the 2 INPUT SELECTOR switches¹ on the **6410** *Digital to Analog Audio Converter*, as Table 1 defines.

5.2 Connecting the 6420 Analog to Digital Audio Converter

To connect your **6420** *Analog to Digital Audio Converter*, as the example in Figure 5 illustrates, do the following:

1. Connect an analog balanced stereo source (for example, a tape player) to the left and right detachable terminal block analog input connectors via shielded twisted pair cables.
2. Connect up to 4 acceptors to the 4 different digital output connectors, as follows:
 - Connect an AES-75 Ω acceptor (for example, a DAT-Recorder) to the AES-75 Ω BNC output connector
 - Connect an AES/EBU acceptor (for example, a DAT-Recorder) to the AES/EBU detachable terminal block output connector using a shielded twisted pair cable (110 Ω)
 - Connect an S/PDIF acceptor (for example, a DAT-Recorder²) to the S/PDIF RCA output connector
 - Connect an optical acceptor (for example, a DAT-Recorder²) to the OPTICAL output connector
3. Connect the 12V DC power adapter to the power socket and connect the adapter to the mains electricity.

¹ Items 10 and 11, in Figure 2

² A small-sized consumer DAT-Recorder

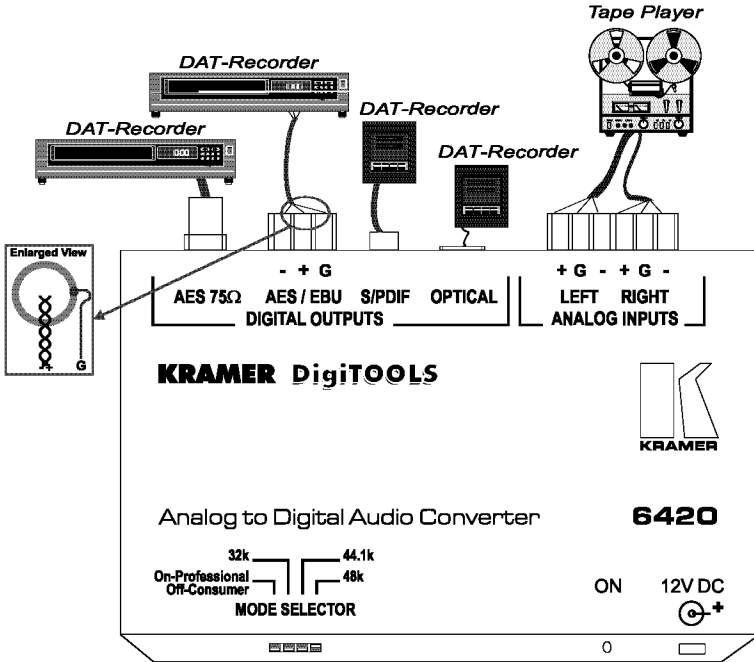

Figure 5: Connecting the 6420 Analog to Digital Audio Converter

5.2.1 Setting the MODE SELECTOR Dipswitches

Set the MODE SELECTOR dipswitches on the **6420 Analog to Digital Audio Converter** to choose the digital audio standard format (professional or consumer) and the appropriate digital sampling frequency.

Figure 6 illustrates the MODE SELECTOR dipswitches of the **6420 Analog to Digital Audio Converter** (48k Consumer is set in this illustration):

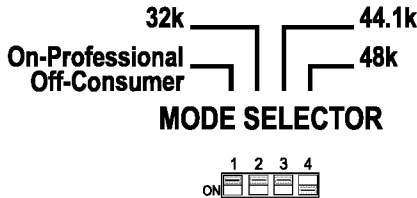

Figure 6: 6420 MODE SELECTOR Dipswitches

To set the MODE SELECTOR dipswitches, do the following:

1. Choose the digital audio standard format (professional or consumer):
 - For the professional format, set DIP 1 ON

- For the consumer format, set DIP 1 OFF
2. Choose the appropriate digital sampling frequency, by setting DIP 2, 3 and 4, as follows:
- For 32k, set DIP 2 ON, and DIPS 3 and 4 OFF
 - For 44.1k, set DIP 3 ON, and DIPS 2 and 4 OFF
 - For 48k, set DIP 4 ON, and DIPS 2 and 3 OFF

6 Technical Specifications

Table 3 and Table 4 include the technical specifications for the **6410 Digital to Analog Audio Converter** and the **6420 Analog to Digital Audio Converter**, respectively.

Table 3: 6410 Digital to Analog Audio Converter Technical Specifications

Inputs:	4 digital audio inputs: AES 75Ω; AES/EBU; S/PDIF; TosLink Optical
Outputs:	2 analog outputs: detachable terminal blocks; 3.5mm headphone jack
Sampling:	32, 44.1, 48, kHz sampling frequencies
Standards:	AES/EBU; AES-ID3; S/PDIF; TosLink Optical
Gain:	+ 14dB/dBFS
Frequency Response:	20Hz 20 kHz @ -3 dB
TND + N:	<0.01%
SNR:	>80 dB
Dimensions:	12 cm x 7.5 cm x 2.5 cm (4.7" x 2.95" x 0.98", W, D, H)
Power Source:	12 VDC, 200mA
Weight:	0.3 kg (0.66 lbs.) approx.
Accessories:	Power supply, mounting bracket
Options:	RK-T1 or RK-T3 rack mount kit

Table 4: 6420 Analog to Digital Audio Converter Technical Specifications

Input:	1 analog input on detachable terminal blocks
Outputs:	4 digital audio outputs: AES 75Ω; AES/EBU; S/PDIF; TosLink Optical
Sampling:	32, 44.1, 48, kHz sampling frequencies
Standards:	AES/EBU; AES-ID3; S/PDIF; TosLink Optical
Gain:	- 14dBFS/dB
Frequency Response:	20Hz 20 kHz @ -3 dB
TND + N:	<0.01%
SNR:	>80 dB
Dimensions:	12 cm x 7.5 cm x 2.5 cm (4.7" x 2.95" x 0.98", W, D, H)
Power Source:	12 VDC, 200mA
Weight:	0.3 kg (0.66 lbs.) approx.
Accessories:	Power supply, mounting bracket
Options:	RK-T1 or RK-T3 rack mount kit

LIMITED WARRANTY

Kramer Electronics (hereafter *Kramer*) warrants this product free from defects in material and workmanship under the following terms.

HOW LONG IS THE WARRANTY

Labor and parts are warranted for three years from the date of the first customer purchase.

WHO IS PROTECTED?

Only the first purchase customer may enforce this warranty.

WHAT IS COVERED AND WHAT IS NOT COVERED

Except as below, this warranty covers all defects in material or workmanship in this product. The following are not covered by the warranty:

1. Any product which is not distributed by Kramer, or which is not purchased from an authorized Kramer dealer. If you are uncertain as to whether a dealer is authorized, please contact Kramer at one of the agents listed in the web site www.kramerelectronics.com.
2. Any product, on which the serial number has been defaced, modified or removed.
3. Damage, deterioration or malfunction resulting from:
 - i) Accident, misuse, abuse, neglect, fire, water, lightning or other acts of nature
 - ii) Product modification, or failure to follow instructions supplied with the product
 - iii) Repair or attempted repair by anyone not authorized by Kramer
 - iv) Any shipment of the product (claims must be presented to the carrier)
 - v) Removal or installation of the product
 - vi) Any other cause, which does not relate to a product defect
 - vii) Cartons, equipment enclosures, cables or accessories used in conjunction with the product

WHAT WE WILL PAY FOR AND WHAT WE WILL NOT PAY FOR

We will pay labor and material expenses for covered items. We will not pay for the following:

1. Removal or installations charges.
2. Costs of initial technical adjustments (set-up), including adjustment of user controls or programming. These costs are the responsibility of the Kramer dealer from whom the product was purchased.
3. Shipping charges.

HOW YOU CAN GET WARRANTY SERVICE

1. To obtain service on you product, you must take or ship it prepaid to any authorized Kramer service center.
2. Whenever warranty service is required, the original dated invoice (or a copy) must be presented as proof of warranty coverage, and should be included in any shipment of the product. Please also include in any mailing a contact name, company, address, and a description of the problem(s).
3. For the name of the nearest Kramer authorized service center, consult your authorized dealer.

LIMITATION OF IMPLIED WARRANTIES

All implied warranties, including warranties of merchantability and fitness for a particular purpose, are limited in duration to the length of this warranty.

EXCLUSION OF DAMAGES

The liability of Kramer for any effective products is limited to the repair or replacement of the product at our option. Kramer shall not be liable for:

1. Damage to other property caused by defects in this product, damages based upon inconvenience, loss of use of the product, loss of time, commercial loss; or:
2. Any other damages, whether incidental, consequential or otherwise. Some countries may not allow limitations on how long an implied warranty lasts and/or do not allow the exclusion or limitation of incidental or consequential damages, so the above limitations and exclusions may not apply to you.

This warranty gives you specific legal rights, and you may also have other rights, which vary from place to place.

NOTE: All products returned to Kramer for service must have prior approval. This may be obtained from your dealer.

This equipment has been tested to determine compliance with the requirements of:

- EN-50081: "Electromagnetic compatibility (EMC);
generic emission standard.
Part 1: Residential, commercial and light industry"
- EN-50082: "Electromagnetic compatibility (EMC) generic immunity standard.
Part 1: Residential, commercial and light industry environment".
- CFR-47: FCC Rules and Regulations:
Part 15: "Radio frequency devices
Subpart B – Unintentional radiators"

CAUTION!

- ☒ Servicing the machines can only be done by an authorized Kramer technician. Any user who makes changes or modifications to the unit without the expressed approval of the manufacturer will void user authority to operate the equipment.
- ☒ Use the supplied DC power supply to feed power to the machine.
- ☒ Please use recommended interconnection cables to connect the machine to other components.



**The list of Kramer distributors appears on our web site:
www.kramerelectronics.com**

We welcome your questions, comments and feedback.

Kramer Electronics, Ltd.

3 Am VeOlamo Street. Jerusalem 95463, Israel Tel: (+972 2) 654 4000

Fax: (+972 2) 653 5369, E mail: kramerel@netvision.net.il

P/N: 2900 004019 REV 1