

Kramer Electronics, Ltd.



USER MANUAL

Model:

VP-102xl

UXGA to RGBHV / Audio Interface

Contents

1	Introduction	1
2	Getting Started	1
2.1	Quick Start	1
3	Overview	3
4	Your VP-102xl UXGA to RGBHV / Audio Interface	4
5	Connecting the VP-102xl UXGA to RGBHV / Audio Interface	6
6	Technical Specifications	8

Figures

Figure 1: VP-102xl UXGA to RGBHV / Audio Interface	4
Figure 2: VP-102xl (Top Side Panel)	4
Figure 3: VP-102xl (Lower Side Panel)	4
Figure 4: VP-102xl UXGA to RGBHV / Audio Interface (Underside)	5
Figure 5: Connecting the VP-102xl UXGA to RGBHV / Audio Interface	7

Tables

Table 1: VP-102xl UXGA to RGBHV / Audio Interface Features	5
Table 2: VP-102xl UXGA to RGBHV / Audio Interface (Underside) Features	5
Table 3: Technical Specifications of the VP-102xl UXGA to RGBHV / Audio Interface	8

1 Introduction

Welcome to Kramer Electronics (since 1981): a world of unique, creative and affordable solutions to the infinite range of problems that confront the video, audio and presentation professional on a daily basis. In recent years, we have redesigned and upgraded most of our line, making the best even better! Our 500-plus different models now appear in 8 Groups¹, which are clearly defined by function. Congratulations on purchasing your Kramer TOOLS **VP-102xl UXGA to RGBHV / Audio Interface**, which is ideal for:

- Presentation systems
- Graphics and audio installations in conference rooms and training rooms

The package includes the following items:

- **VP-102xl UXGA to RGBHV / Audio Interface**
- Power adapter (12V DC Input)
- This user manual²

2 Getting Started

We recommend that you:

- Unpack the equipment carefully and save the original box and packaging materials for possible future shipment
- Review the contents of this user manual
- Use Kramer high performance high resolution cables³

2.1 Quick Start

This quick start chart summarizes the basic setup and operation steps.

1 GROUP 1: Distribution Amplifiers; GROUP 2: Video and Audio Switchers, Matrix Switchers and Controllers; GROUP 3: Video, Audio, VGA/XGA Processors; GROUP 4: Interfaces and Sync Processors; GROUP 5: Twisted Pair Interfaces; GROUP 6: Accessories and Rack Adapters; GROUP 7: Scan Converters and Scalers; and GROUP 8: Cables and Connectors

2 Download up-to-date Kramer user manuals from the Internet at this URL: <http://www.kramerelectronics.com>

3 The complete list of Kramer cables is on our Web site at <http://www.kramerelectronics.com>

Step 1: Connect the input - see section 5

Connect the UXGA input:

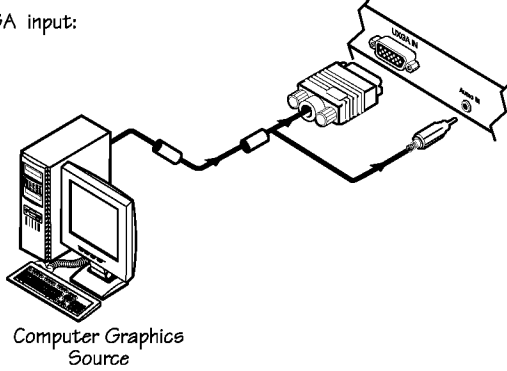

Step 2: Connect the output - see section 5

Connect the RGBHV output:

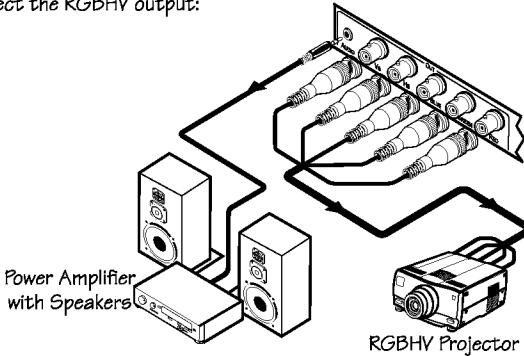

Step 3: Connect the power

Step 4: Adjust the EQ. - see section 4

Adjust the EQ. Trimmer (on the lower side panel) if required, using a screwdriver

Step 5: Set the underside switches - see section 4

Set the ID Bit:

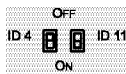

Set the audio level trimmers:

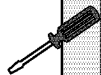

3 Overview

The **VP-102xl** is a high performance UXGA¹ and audio interface that accepts a computer graphics (UXGA) signal on an HD15 connector and outputs it to RGBHV on BNC connectors.

In addition, the **VP-102xl** includes:

- A video bandwidth of 420MHz, to ensure transparent operation at multiple resolutions including UXGA
- A local monitor loop-through on an active HD15F connector
- An unbalanced stereo audio input on a 3.5mm mini jack, and a corresponding unbalanced stereo audio output on a 3.5mm mini jack
- Cable equalization control
- Left and right audio level controls
- ID Bit control switches

Achieving the best performance means:

- Connecting only good quality connection cables, thus avoiding interference, deterioration in signal quality due to poor matching, and elevated noise levels (often associated with low quality cables)
- Avoiding interference from neighboring electrical appliances and positioning your **VP-102xl** away from moisture, excessive sunlight and dust



Caution – No operator-serviceable parts inside unit.

Warning – Use only the Kramer Electronics input power wall adapter that is provided with this unit².

Warning – Disconnect power and unplug unit from wall before installing or removing device or servicing unit.

¹ The terminology UXGA is used throughout this manual, where this implies any RGBHV signal on an HD15 connector having a resolution from VGA up to UXGA

² For example: model number AD2512C, part number 2535-000251

4 Your VP-102xl UXGA to RGBHV / Audio Interface

Figure 1, Figure 2, Figure 3 and Table 1 define the **VP-102xl**:

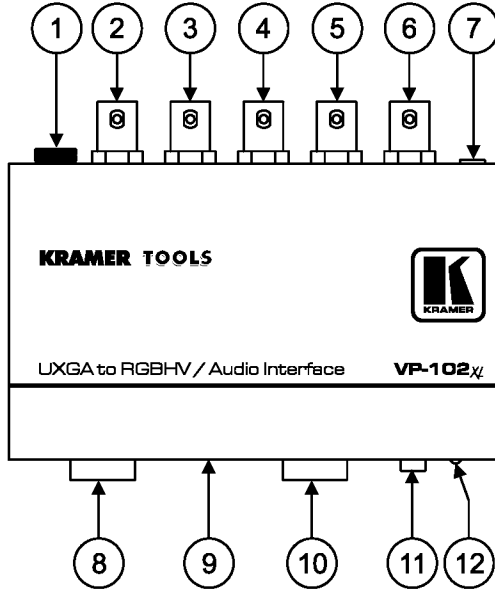

Figure 1: VP-102xl UXGA to RGBHV / Audio Interface

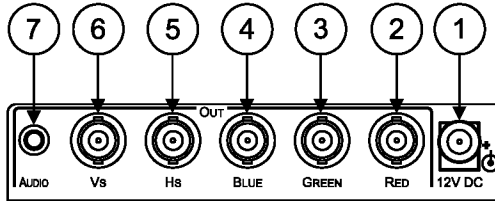

Figure 2: VP-102xl (Top Side Panel)

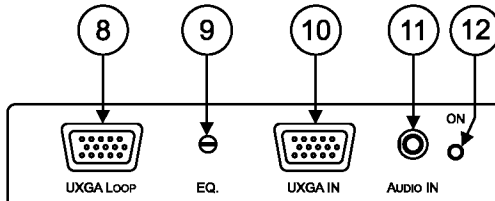

Figure 3: VP-102xl (Lower Side Panel)

Table 1: VP-102xl UXGA to RGBHV / Audio Interface Features

#	Feature	Function	
1	12V DC	+12V DC connector for powering the unit	
2	OUT	RED BNC Connector	Amplified and buffered red signal output
3		GREEN BNC Connector	Amplified and buffered green signal output
4		BLUE BNC Connector	Amplified and buffered blue signal output
5		Hs BNC Connector	Horizontal sync for amplified and buffered horizontal sync output
6		Vs BNC Connector	Vertical sync for amplified and buffered vertical sync output
7	AUDIO OUT 3.5mm Mini Jack	Connects to the unbalanced stereo audio acceptor	
8	UXGA LOOPHD15F Connector	For UXGA looping to increase output availability (for example, to connect to a local display)	
9	EQ. Control Trimmer	Adjusts ¹ the video EQ. (equalization) compensation	
10	UXGA IN HD15F Connector	Connect to the computer graphics source	
11	AUDIO IN 3.5mm Mini Jack	Connects to the unbalanced stereo audio source	
12	ON LED	Illuminates when receiving power	

Figure 4 and Table 2 define the underside of the VP-102xl:

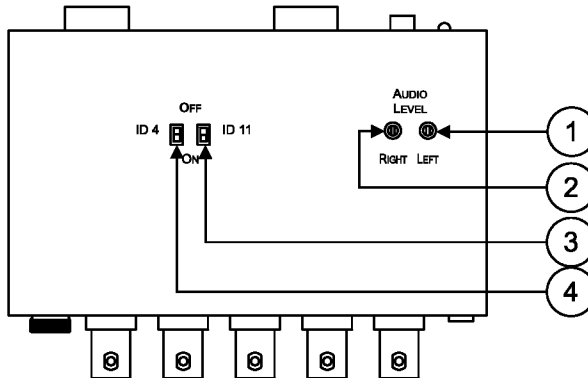

Figure 4: VP-102xl UXGA to RGBHV / Audio Interface (Underside)

Table 2: VP-102xl UXGA to RGBHV / Audio Interface (Underside) Features

#	Feature	Function	
1	AUDIO LEVEL	LEFT Trimmer	Adjusts ¹ the left output audio signal level
2		RIGHT Trimmer	Adjusts ¹ the right output audio signal level
3	ID ² 11 Switch	Slide down to set to ON ³ ; up to set to OFF	
4	ID ² 4 Switch	Slide down to set to ON ³ ; up to set to OFF	

1 Insert a screwdriver into the small hole and carefully rotate it, trimming the appropriate level

2 ID BIT

3 The default. Enabling the notebook or laptop to output a UXGA signal to an external VGA monitor

5 Connecting the VP-102xl UXGA to RGBHV / Audio Interface

To connect your **VP-102xl**, as the example in Figure 5 illustrates, do the following¹:

1. Connect your UXGA source (for example, a computer) to the UXGA IN HD15F connector and to the AUDIO IN 3.5mm mini jack, for example, using a Kramer C-GMA/GMA cable (VGA HD15M +Audio jack to VGA HD15M +Audio jack)².
2. If required, connect a local display to the UXGA LOOP HD15F connector.
3. Connect the BNC OUTPUT connectors (RED, GREEN, BLUE, Hs and Vs) to the RGBHV acceptor (for example, a projector).
4. Connect the unbalanced stereo AUDIO OUT 3.5mm mini jack to an acceptor (for example, power amplifier and speakers).
5. Connect the 12V DC power adapter (wall transformer) to the 12V DC socket and connect the transformer to the mains electricity.
6. If required, adjust³ the:
 - Cable compensation equalization level
 - Left and right audio output signal level
7. If required, set the ID Bit to ON.

1 Switch OFF the power on each device before connecting it to your VP-102xl. After powering up your VP-102xl, switch on the power on each device

2 Not supplied. The complete list of Kramer cables is on our Web site at <http://www.kramerelectronics.com>

3 Use a screwdriver to rotate the potentiometer, adjusting the appropriate level

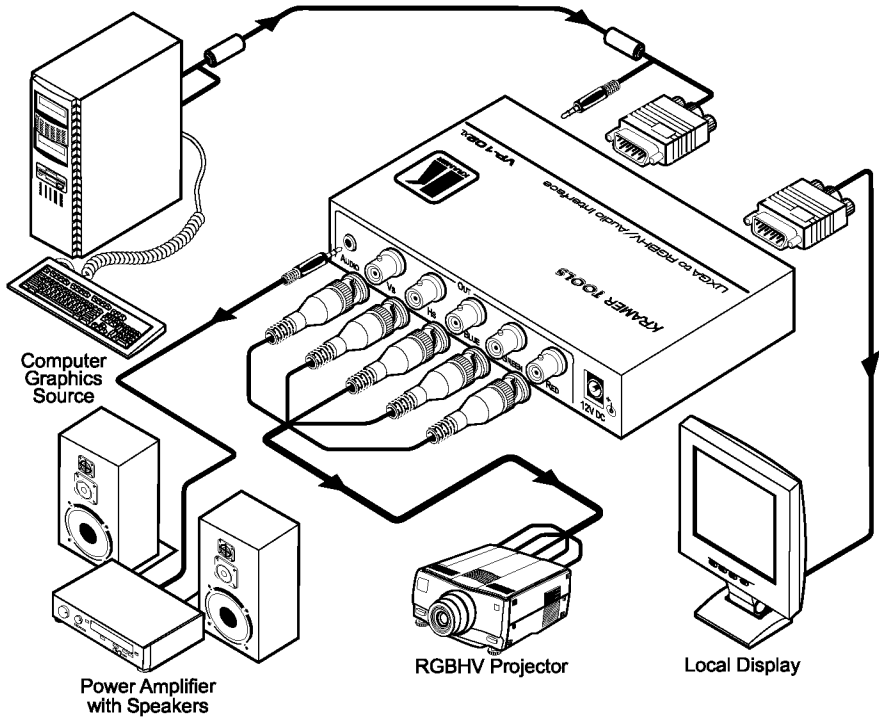

Figure 5: Connecting the VP-102xl UXGA to RGBHV / Audio Interface

6 Technical Specifications

Table 3 includes the technical specifications:

Table 3: *Technical Specifications¹ of the VP-102xl UXGA to RGBHV / Audio Interface*

INPUTS:	1 UXGA on an HD15F connector 1 unbalanced stereo audio on a 3.5mm Mini Jack	
OUTPUTS:	1 RGBHV on 5 BNC connectors 1 UXGA active loop on an HD15F connector 1 unbalanced stereo audio on a 3.5mm Mini Jack	
MAX. OUTPUT LEVEL:	VIDEO: 2Vpp	AUDIO: 6.8Vpp
BANDWIDTH (-3dB):	VIDEO: 420MHz	AUDIO: >100kHz
DIFF. GAIN:	0.05%	
DIFF. PHASE:	0.03°	
K-FACTOR:	<0.01%	
S/N RATIO:	VIDEO: 76dB	AUDIO: 90dB
CONTROLS:	EQ.: 0 to +7.4dB @ 50MHz, Audio Level: -72dB to +6.2dB	
COUPLING:	VIDEO: DC	AUDIO: INPUT: AC; OUTPUT: DC
AUDIO THD + NOISE:	0.017%	
AUDIO 2nd HARMONIC:	0.001%	
POWER SOURCE:	12 VDC, 142mA	
DIMENSIONS:	12cm x 7.18cm x 2.42cm (4.73" x 2.83" x 0.95"), W, D, H	
WEIGHT:	0.3 kg. (0.67 lbs.) approx.	
ACCESSORIES:	Power supply, mounting bracket	

¹ Specifications are subject to change without notice

LIMITED WARRANTY

Kramer Electronics (hereafter *Kramer*) warrants this product free from defects in material and workmanship under the following terms.

HOW LONG IS THE WARRANTY

Labor and parts are warranted for seven years from the date of the first customer purchase.

WHO IS PROTECTED?

Only the first purchase customer may enforce this warranty.

WHAT IS COVERED AND WHAT IS NOT COVERED

Except as below, this warranty covers all defects in material or workmanship in this product. The following are not covered by the warranty:

1. Any product which is not distributed by Kramer, or which is not purchased from an authorized Kramer dealer. If you are uncertain as to whether a dealer is authorized, please contact Kramer at one of the agents listed in the web site www.kramerelectronics.com.
2. Any product, on which the serial number has been defaced, modified or removed.
3. Damage, deterioration or malfunction resulting from:
 - i) Accident, misuse, abuse, neglect, fire, water, lightning or other acts of nature
 - ii) Product modification, or failure to follow instructions supplied with the product
 - iii) Repair or attempted repair by anyone not authorized by Kramer
 - iv) Any shipment of the product (claims must be presented to the carrier)
 - v) Removal or installation of the product
 - vi) Any other cause, which does not relate to a product defect
 - vii) Cartons, equipment enclosures, cables or accessories used in conjunction with the product

WHAT WE WILL PAY FOR AND WHAT WE WILL NOT PAY FOR

We will pay labor and material expenses for covered items. We will not pay for the following:

1. Removal or installations charges.
2. Costs of initial technical adjustments (set-up), including adjustment of user controls or programming. These costs are the responsibility of the Kramer dealer from whom the product was purchased.
3. Shipping charges.

HOW YOU CAN GET WARRANTY SERVICE

1. To obtain service on you product, you must take or ship it prepaid to any authorized Kramer service center.
2. Whenever warranty service is required, the original dated invoice (or a copy) must be presented as proof of warranty coverage, and should be included in any shipment of the product. Please also include in any mailing a contact name, company, address, and a description of the problem(s).
3. For the name of the nearest Kramer authorized service center, consult your authorized dealer.

LIMITATION OF IMPLIED WARRANTIES

All implied warranties, including warranties of merchantability and fitness for a particular purpose, are limited in duration to the length of this warranty.

EXCLUSION OF DAMAGES

The liability of Kramer for any effective products is limited to the repair or replacement of the product at our option. Kramer shall not be liable for:

1. Damage to other property caused by defects in this product, damages based upon inconvenience, loss of use of the product, loss of time, commercial loss; or:
2. Any other damages, whether incidental, consequential or otherwise. Some countries may not allow limitations on how long an implied warranty lasts and/or do not allow the exclusion or limitation of incidental or consequential damages, so the above limitations and exclusions may not apply to you.

This warranty gives you specific legal rights, and you may also have other rights, which vary from place to place.

NOTE: All products returned to Kramer for service must have prior approval. This may be obtained from your dealer. This equipment has been tested to determine compliance with the requirements of:

EN-50081:	"Electromagnetic compatibility (EMC); generic emission standard. Part 1: Residential, commercial and light industry"
EN-50082:	"Electromagnetic compatibility (EMC) generic immunity standard. Part 1: Residential, commercial and light industry environment".
CFR-47:	FCC Rules and Regulations: Part 15: "Radio frequency devices Subpart B – Unintentional radiators"

CAUTION!

- Servicing the machines can only be done by an authorized Kramer technician. Any user who makes changes or modifications to the unit without the expressed approval of the manufacturer will void user authority to operate the equipment.
- Use the supplied DC power supply to feed power to the machine.
- Please use recommended interconnection cables to connect the machine to other components.





For the latest information on our products and a list of Kramer distributors, visit our Web site: www.kramerelectronics.com, where updates to this user manual may be found. We welcome your questions, comments and feedback.

 <p>Caution</p>	<p>Safety Warning: Disconnect the unit from the power supply before opening/servicing.</p>
---	---



Kramer Electronics, Ltd.
Web site: www.kramerelectronics.com
E-mail: info@kramerelectronics.com
P/N: 2900-000223 REV 1