

Crestron **SWAMP(I)E-4**  
Sonnex™ Multiroom Audio Expander,  
4 Zone

---

Operations Guide



This document was prepared and written by the Technical Documentation department at:



## Important Safety Instructions

- Read these instructions.
- Keep these instructions.
- Heed all warnings.
- Follow all instructions.
- Do not use this apparatus near water.
- Clean only with dry cloth.
- Do not block any ventilation openings. Install in accordance with the manufacturer's instructions.
- Do not install near any heat sources such as radiators, heat registers, stoves, or other apparatus (including amplifiers) that produce heat.
- Do not defeat the safety purpose of the polarized or grounding-type plug. A polarized plug has two blades with one wider than the other. A grounding-type plug has two blades and a third grounding prong. The wide blade or the third prong are provided for your safety. If the provided plug does not fit into your outlet, consult an electrician for replacement of the obsolete outlet.
- Protect the power cord from being walked on or pinched particularly at plugs, convenience receptacles, and the point where they exit from the apparatus.
- Only use attachments/accessories specified by the manufacturer.
- Use only with the cart, stand, tripod, bracket or table specified by the manufacturer or sold with the apparatus. When a cart is used, use caution when moving the cart/apparatus combination to avoid injury from tip-over. 
- Unplug this apparatus during lightning storms or when unused for long periods of time.
- Refer all servicing to qualified service personnel. Servicing is required when the apparatus has been damaged in any way, such as power-supply cord or plug is damaged, liquid has been spilled or objects have fallen into the apparatus, the apparatus has been exposed to rain or moisture, does not operate normally, or has been dropped.
- Disconnect power prior to connecting or disconnecting equipment.
- Do not install in direct sunlight.
- The apparatus must be installed in a way that the power cord can be removed either from the wall outlet or from the device itself in order to disconnect the mains power.
- Prevent foreign objects from entering the device.

### WARNING:

TO REDUCE THE RISK OF FIRE OR ELECTRIC SHOCK, DO NOT EXPOSE THIS APPARATUS TO RAIN OR MOISTURE. THE APPARATUS SHALL NOT BE EXPOSED TO DRIPPING OR SPLASHING. OBJECTS FILLED WITH LIQUIDS, SUCH AS VASES, SHOULD NOT BE PLACED ON THE APPARATUS.

### WARNING:

TO PREVENT ELECTRIC SHOCK, DO NOT REMOVE COVER. THERE ARE NO USER SERVICEABLE PARTS INSIDE. ONLY QUALIFIED SERVICE PERSONNEL SHOULD PERFORM SERVICE.



AVIS: RISQUE DE CHOC ELECTRIQUE NE PAS OUVRIR



The lightning flash with arrowhead symbol, within an equilateral triangle, is intended to alert the user to the presence of uninsulated "dangerous voltage" within the product's enclosure that may be of sufficient magnitude to constitute a risk of electric shock to persons.



The exclamation point within an equilateral triangle is intended to alert the user to the presence of important operating and maintenance (servicing) instructions in the literature accompanying the appliance.

### WARNING:

THIS IS AN APPARATUS WITH CLASS I CONSTRUCTION. IT SHALL BE CONNECTED TO AN ELECTRICAL OUTLET WITH AN EARTHING GROUND TERMINAL.

### IMPORTANT:

The SWAMPE-4 and SWAMPIE-4 can be used with Class 2 output wiring.

## Regulatory Compliance

As of the date of manufacture, the SWAMPE-4 and SWAMPIE-4 have been tested and found to comply with specifications for CE marking and standards per EMC and Radiocommunications Compliance Labelling.



---

### Federal Communications Commission (FCC) Compliance Statement

This device complies with part 15 of the FCC Rules. Operation is subject to the following conditions:

(1) This device may not cause harmful interference and (2) this device must accept any interference received, including interference that may cause undesired operation.

**CAUTION:** Changes or modifications not expressly approved by the manufacturer responsible for compliance could void the user's authority to operate the equipment.

**NOTE:** This equipment has been tested and found to comply with the limits for a Class B digital device, pursuant to part 15 of the FCC Rules. These limits are designed to provide reasonable protection against harmful interference in a residential installation. This equipment generates, uses and can radiate radio frequency energy and, if not installed and used in accordance with the instructions, may cause harmful interference to radio communications. However, there is no guarantee that interference will not occur in a particular installation. If this equipment does cause harmful interference to radio or television reception, which can be determined by turning the equipment off and on, the user is encouraged to try to correct the interference by one or more of the following measures:

- Reorient or relocate the receiving antenna
- Increase the separation between the equipment and receiver
- Connect the equipment into an outlet on a circuit different from that to which the receiver is connected
- Consult the dealer or an experienced radio/TV technician for help

---

### Industry Canada (IC) Compliance Statement

This Class B digital apparatus complies with Canadian ICES-003.

Cet appareil numérique de la classe B est conforme à la norme NMB-003 du Canada.

---

The specific patents that cover Crestron products are listed at [patents.crestron.com](http://patents.crestron.com)

Crestron, the Crestron logo, AIR, Cresnet, Excite, Sonnex, Sonnex Speaker Protect, SSP, and SystemBuilder are either trademarks or registered trademarks of Crestron Electronics, Inc. in the United States and/or other countries. Windows is either a trademark or registered trademark of Microsoft Corporation in the United States and/or other countries. Other trademarks, registered trademarks and trade names may be used in this document to refer to either the entities claiming the marks and names or their products. Crestron disclaims any proprietary interest in the marks and names of others.

©2012 Crestron Electronics, Inc.



# Contents

<b>Sonnex™ Multiroom Audio Expander, 4 Zone: SWAMP(I)E-4</b>	<b>1</b>
Introduction .....	1
Features and Functions .....	1
Applications.....	2
Specifications .....	3
Physical Description.....	5
Setup.....	8
Sonnex Link Wiring .....	8
Installation.....	8
Hardware Hookup .....	10
Configuration.....	14
Programming Software.....	15
Software Requirements for the PC .....	15
Programming with SystemBuilder .....	15
Programming with SIMPL Windows .....	15
Uploading and Upgrading.....	17
Establishing Communication.....	17
Programs and Firmware .....	17
Operation .....	18
Problem Solving .....	19
Troubleshooting.....	19
Check Wiring .....	19
Reference Documents.....	19
Further Inquiries .....	19
Future Updates .....	20
Return and Warranty Policies.....	21
Merchandise Returns / Repair Service .....	21
Crestron Limited Warranty.....	21



# Sonnex™ Multiroom Audio Expander, 4 Zone: SWAMP(I)E-4

---

## Introduction

The SWAMPE-4 is a 4-zone expander for the Sonnex™ Multiroom Audio System (SWAMP-24X8) from Crestron®. It adds four stereo amplified zones supporting full room control and source selection, with advanced DSP, speaker profiles, output bussing, mono summing, amplifier bridging and monitoring. The SWAMPE-4 interfaces with the SWAMP-24X8 via a single CAT5e shielded twisted pair (STP) cable up to 200 ft (61 m) in length\*. Adding the S-EXT1-S Sonnex Link Over Fiber Extender (sold separately) can increase the distance between a SWAMPE-4 and SWAMP-24X8 up to an additional 2000 feet (610 meters). Plug-and-play connectivity affords an extremely easy installation, affording full control access to all the SWAMPE-4 functions through the SWAMP-24X8.

While the main SWAMP-24X8 unit resides in the central equipment rack along with all the source devices, the SWAMPE-4 is ideally designed for installation at a remote location near the rooms it serves. This “decentralized” approach minimizes speaker wiring for higher performance and efficiency, and a faster, easier and less expensive installation.

Like the SWAMP-24X8, the SWAMPE-4 delivers a generous 140 Watts into 8 Ohms and 240 Watts into 4 Ohms per each of eight channels (configured as four zones), and is bridgeable for 400 Watts per channel at 8 Ohms. Even with such incredible power, the SWAMPE-4 runs cool and efficiently, and requires only three rack spaces for mounting.

## Features and Functions

- Part of a multiroom audio distribution system for homes and offices
- High-efficiency audiophile grade amplification built in
- 140 Watts/Channel @ 8 Ohms, 400 Watts/Channel bridged
- Four amplified stereo zone outputs
- Linked operation of multiple adjacent zones
- Bridgeable outputs—extra power for pools and other large areas
- Sonnex Link—provides one-wire, plug-and-play connection to SWAMP-24X8 Audio System up to 200 feet (61 meters) away
- User adjustable volume, bass, treble, loudness, and selectable “tone profiles”

*(Continued on following page)*

\* For connection of the Sonnex Link between the SWAMPE-4 and the SWAMP-24X8 or S-EXT1-S, use Crestron DM-CBL-8G or high-quality CAT5e shielded twisted-pair cable with DM-8G-CONN connectors. The maximum cable length is 200 feet (61 meters) per run.

## Features and Functions

(Continued)

- Installer adjustable 5-band graphic or parametric EQ per zone
- Dynamic Range Control—maintains even listening levels in both quiet and loud ambient environments
- Speaker Profiles—allows upload of custom preset speaker settings
- Sonnex Speaker Protect™—affords extra headroom while preventing component damage
- Individual zone power control and global standby
- Setup and adjustment via SWAMP-24X8 front panel or Sonnex Tools software
- Remote fault monitoring
- Heavy duty detachable terminal blocks ease speaker wire termination
- Low power consumption, cool-running operation
- 3-space 19” rack-mountable

The SWAMPE-4 and SWAMP(IE)-4 are functionally identical. For simplicity within this guide, the term “SWAMPE-4” is used except where noted.

## Applications

The following diagram shows a SWAMPE-4 in a multi-zone application.

*SWAMPE-4 in a Multi-Zone Application*

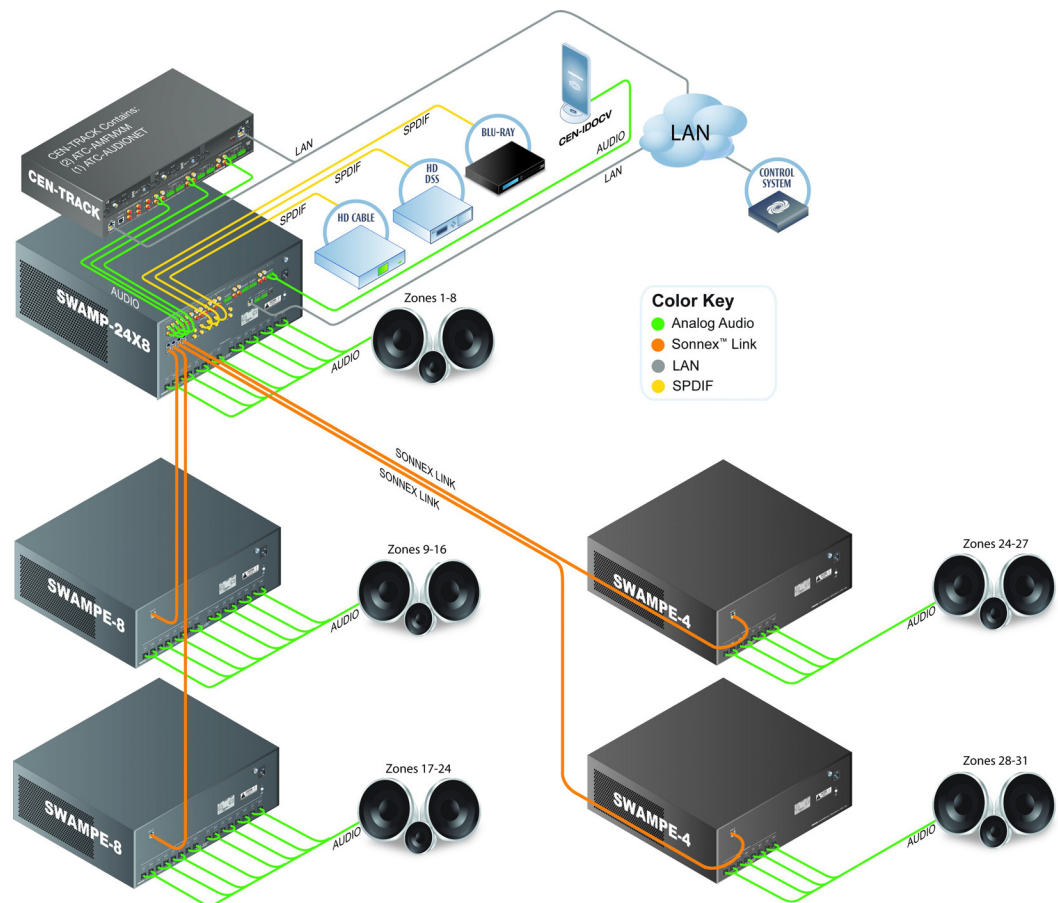



## Specifications

Specifications for the SWAMP(I)E-4 are listed in the following table.

### *SWAMP(I)E-4 Specifications*

<b>SPECIFICATION</b>	<b>DETAILS</b>
Audio	
Input Signal Types	Sonnex Link
Output Signal Types	Stereo speaker level
Digital-to-Analog Conversion <sup>1</sup>	24-bit 48 kHz
Output Power <sup>1</sup>	140 Watts per channel at 8 Ohms 240 Watts per channel at 4 Ohms 400 Watts per channel at 8 Ohms bridged
Damping Factor <sup>1</sup>	> 200 @ 20 Hz
Amplifier Monitoring <sup>1</sup>	Over Current, Over/Under Voltage, Over Temperature, DC Offset, Clipping
Frequency Response <sup>1</sup>	20 Hz to 20 kHz, ±0.5 dB
Total Harmonic Distortion (THD) <sup>1</sup>	0.02%
S/N Ratio <sup>1</sup>	>105 dB S/PDIF in, >100 dB balanced or unbalanced analog in, A-weighted
Stereo Separation <sup>1</sup>	> 90 dB
Zone Separation <sup>1</sup>	> 95 dB
Zone Volume Level Control <sup>1</sup>	-80.0 to +20.0 dB, adjustable from 0% to 100% plus mute
Bass Control <sup>1</sup>	±12.0 dB
Treble Control <sup>1</sup>	±12.0 dB
Loudness Compensation <sup>1</sup>	On/Off
Dynamic Range Control <sup>1</sup>	On/Off
Balance Control <sup>1</sup>	Left/right adjustable
Mono Summing <sup>1</sup>	Selectable
Power Limiting <sup>1</sup>	Sonnex Speaker Protect (SSP™) output limiting <sup>2</sup> ; Configurable 40 to 140 Watts @ 8 Ohms 40 to 240 Watts @ 4 Ohms 40 to 400 Watts @ 8 Ohms bridged
Tone Profiles <sup>1</sup>	Flat, Classical, Jazz, Pop, Rock, Spoken Word
EQ Modes <sup>1</sup>	5-band graphic or 5-band parametric EQ
GEQ Center Frequencies <sup>1</sup>	63, 250, 1k, 4k, 16 kHz
GEQ Gain <sup>1</sup>	±12.0 dB per band
PEQ Filter Types	EQ, High Pass, Low Pass, Treble Shelf, Bass Shelf, Notch
PEQ Center Frequency <sup>1</sup>	10 to 20,000 Hz per band
PEQ Gain <sup>1</sup>	±12.0 dB per band
PEQ Bandwidth <sup>1</sup>	0.1 to 3.5 octaves per band

*(Continued on following page)*

*SWAMP(I)E-4 Specifications (Continued)*

SPECIFICATION	DETAILS
Audio (Continued)	
Speaker Profiles <sup>1</sup>	Comprises 5-band GEQ and SSP settings
Bus Volume Offset <sup>1</sup>	±12.0 dB per zone for output bussing
Communications	
Sonnex Link	64-channel (48 utilized) digital audio with embedded control, auto-discovery, auto-negotiating
Power Requirements	
Main Power	
SWAMPE-4	6 Amps @ 120 Volts AC, 50/60 Hz
SWAMPIE-4	3 Amps @ 220-240 Volts AC, 50/60 Hz
Environmental	
Temperature	41° to 104° F (5° to 40° C)
Humidity	10% to 90% RH (non-condensing)
Heat Dissipation	300 BTU/Hr (140 W @ 8 Ω) 450 BTU/Hr (240 W @ 4 Ω)
Enclosure	
Chassis	Metal with black finish, vented sides, variable-speed fan-cooled
Front Panel	Extruded aluminum, black finish with polycarbonate label overlay
Mounting	Freestanding or 3U 19-inch rack-mountable (feet and rack ears included)
Dimensions	
Height	5.83 in (149 mm) with feet 5.20 in (133 mm) without feet
Width	19.00 in (483 mm) with ears 17.29 in (439 mm) without ears
Depth	18.22 in (463 mm)
Weight	60.0 lbs (27.3 kg)
Available Accessories	
AIR-SR	AIR™ Outdoor Surface Mount Speakers
DM-CBL-8G	High Performance CAT5e Shielded Twisted Pair Cable
DM-8G-CONN-100	Cable Connector for DM-CBL-8G, 100-Pack
DM-8G-CRIMP	Crimping Tool for DM-8G-CONN
EXCITE-IC	Excite™ In-Ceiling Speakers
EXCITE-IW	Excite In-Wall Speakers
S-EXT1-S	Sonnex Link Over Fiber Extender
SAT-70V/100V-2	Sonnex Output Transformer, 2 Channels
SAT-70V/100V-4	Sonnex Output Transformer, 4 Channels
SWAMP(I)-24X8	Sonnex Multiroom Audio System

1. Typical of up to four amplified stereo zone outputs
2. As speaker ratings vary greatly across manufacturers, there is no guarantee that Sonnex Speaker Protect protects against speaker damage in all situations.

## Physical Description

This section provides information on the connections, controls and indicators available on the SWAMPE-4.

*SWAMPE-4 Physical View (Front)*







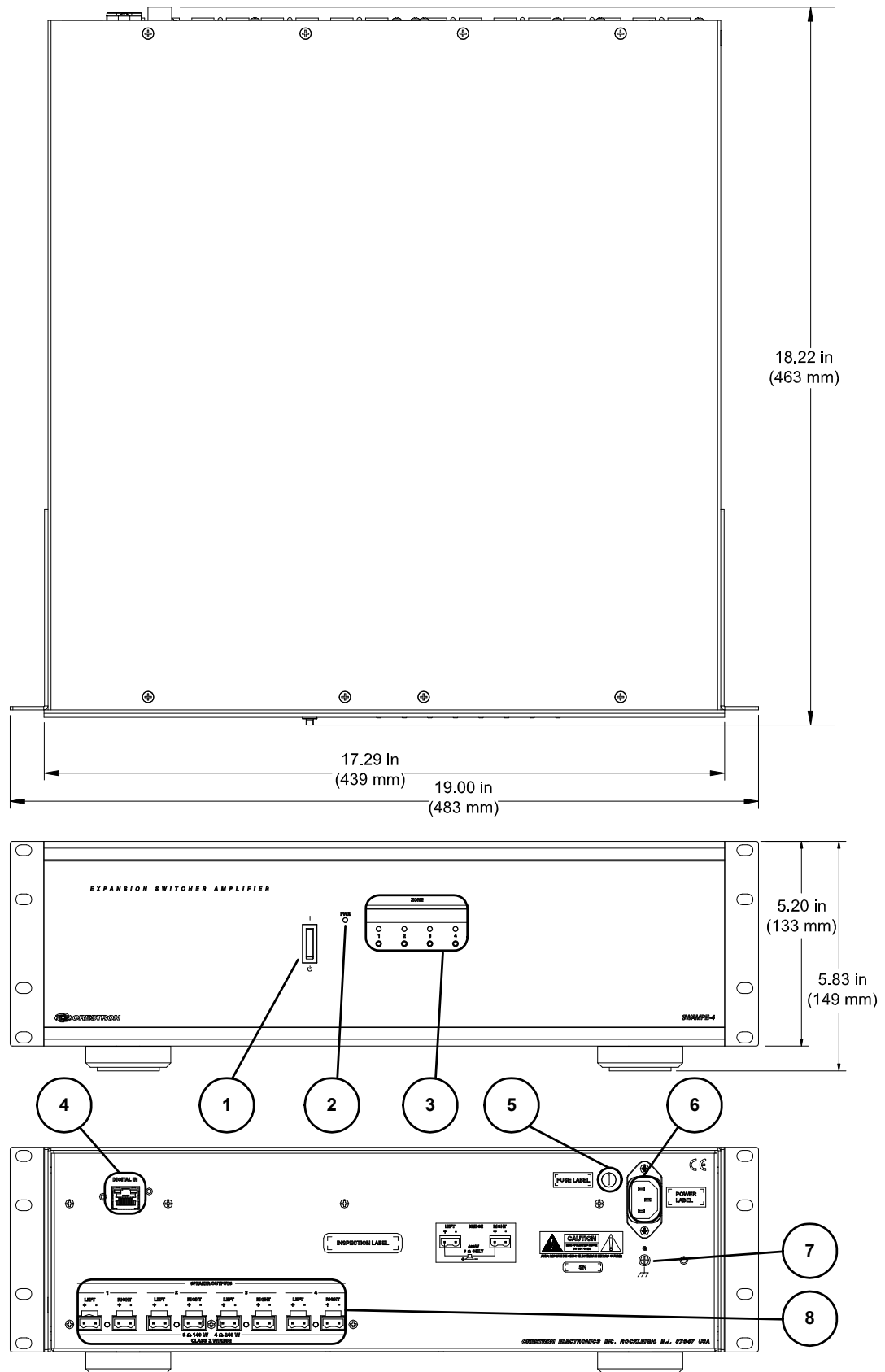

*SWAMPE-4 Physical View (Rear)*



*SWAMPE-4 Overall Dimensions*

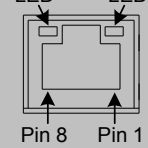

*Connectors, Controls & Indicators*

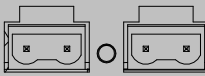
#	CONNECTORS <sup>1</sup> , CONTROLS & INDICATORS	DESCRIPTION
1	<p>On/Off</p> 	(1) Rocker switch, turns unit on and off
2	PWR LED	(1) Green LED indicates unit is turned on
3	<p>ZONE (1-4) Buttons and LEDs</p> 	(4) Push buttons and green LEDs, select output zone for routing and adjustment
4	<p>DIGITAL IN</p> <p>Green LED      Yellow LED</p>  <p>Pin 8      Pin 1</p>	(1) 8-wire RJ-45 female (8P8C modular jack); Sonnex link input; Connect to SWAMP-24X8 Multiroom Audio System <sup>2</sup> or S-EXT1-S Sonnex Link Over Fiber Extender <sup>2</sup> (each sold separately) Green LED indicates link status; Amber LED indicates data communication
5	<p>FUSE</p> 	The SWAMPE-4 requires a T8AH (1/4" x 1-1/4", 250 V, 8 A, time-lag, high-rupture rated) fuse <sup>3</sup> ; The SWAMPIE-4 requires a T4AH (5 mm x 20 mm, 250 V, 4 A, time-lag, high-rupture rated) fuse <sup>3</sup>
6	<p>120V~50/60Hz MAX 6A<sup>4</sup></p> 	(1) IEC C14 male chassis plug, main power input; Mates with removable power cord (included)
7	<p>GROUND</p> 	(1) 6-32 screw, chassis ground lug
8	<p>SPEAKER OUTPUTS (1-4)</p> <p>LEFT      RIGHT</p> <p>+ -      + -</p> 	(8) 2-pin 7.62 mm 15 A detachable terminal blocks; Power amplifier outputs; Wire Size: Terminals accept up to 14 AWG; The following outputs can be bridged together: 1 and 2 (L+R), 3 and 4 (L+R) (4) Red LEDs, indicate adjacent outputs are configured for bridged operation

**NOTE:** Outputs can only be bridged into an 8 ohm load.

1. Interface connectors for **SPEAKER OUTPUTS** ports are provided with the unit.
2. For connection of the Sonnex Link between the SWAMPE-4 and the SWAMP-24X8 or S-EXT1-S, use Crestron DM-CBL-8G or high-quality CAT5e shielded twisted-pair cable with DM-8G-CONN connectors. The maximum cable length is 200 feet (61 meters) per run.
3. Refer to "Fuse Replacement" on page 13 for additional details.
4. Port on SWAMPIE-4 is labeled **220-240V~50/60Hz MAX 3A**.

---

## Setup

### Sonnex Link Wiring

Crestron recommends using Crestron DM-CBL-8G or high-quality CAT5e shielded twisted-pair cable for Sonnex Link connections between the SWAMPE-4 and the SWAMP-24X8 or S-EXT1-S.

---

**NOTE:** Shielded connectors such as the DM-8G-CONN (sold separately) must be used.

---

DM-CBL-8G wire can carry Sonnex Link signals up to 200 feet (61 meters).

### Installation

#### Ventilation

The SWAMPE-4 should be used in a well-ventilated area. The venting holes should not be obstructed under any circumstances.

To prevent overheating, do not operate this product in an area that exceeds the environmental temperature range listed in the table of specifications. Consider using forced air ventilation and/or incrementing the spacing between units to reduce overheating. Consideration must be given if installed in a closed or multi-unit rack assembly since the operating ambient temperature of the environment may be greater than the room ambient temperature. Contact with thermal insulating materials should be avoided on all sides of the unit.

#### Rack Mounting

The SWAMPE-4 can be mounted in a rack or stacked with other equipment. Two “ears” are provided with the SWAMPE-4 so that the unit can be rack mounted. These ears must be installed prior to mounting. Complete the following procedure to attach the ears to the unit. The only tool required is a #1 or #2 Phillips screwdriver.

---

**WARNING:** To prevent bodily injury when mounting or servicing this unit in a rack, observe the following guidelines:

- When mounting this unit in a partially filled rack, load the rack from the bottom to the top with the heaviest component at the bottom of the rack.
- If the rack is provided with stabilizing devices, install the stabilizers before mounting or servicing the unit in the rack.

**NOTE:** Feet are preinstalled for tabletop mounting or stacking. If the unit is to be rack mounted, the feet are not required and can be removed to provide more space in the rack.

**NOTE:** Reliable earthing of rack-mounted equipment should be maintained. Particular attention should be given to supply connections other than direct connections to the branch circuit (such as the use of power strips).

---

To install the ears:

1. Using a #1 or #2 Phillips screwdriver, remove the feet installed on the bottom of the SWAMPE-4.
2. There are screws that secure each side of the SWAMPE-4 top cover. Using a #1 or #2 Phillips screwdriver, remove the four screws closest to the front panel from one side of the unit. Set aside the screws for later use in step 4.
3. Position a rack ear so that its mounting holes align with the holes vacated by the screws in step 2.
4. Secure the ear to the unit with the four screws from step 2 and two of the additional screws that are shipped with the SWAMPE-4, as shown in the following diagram.

*Ear Attachment for Rack Mounting*

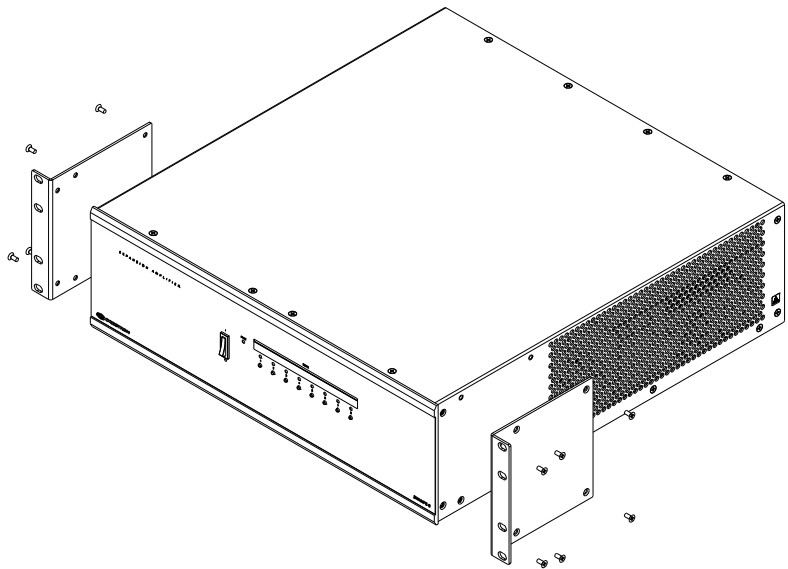

5. Repeat procedure (steps 2 through 4) to attach the remaining ear to the opposite side.

**Stacking**

Four “feet” are preinstalled with the SWAMPE-4 so that if the unit is not rack mounted, the feet can provide stability when the unit is placed on a flat surface or stacked.

---

**NOTE:** No more than two SWAMPE-4 units should be stacked.

---

## Hardware Hookup

### Connect the Device

Make the necessary connections as called out in the illustration that follows this paragraph. Refer to “Sonnex Link Wiring” on page 8 for additional information. Apply power after all connections have been made.

### Hardware Connections for the SWAMPE-4

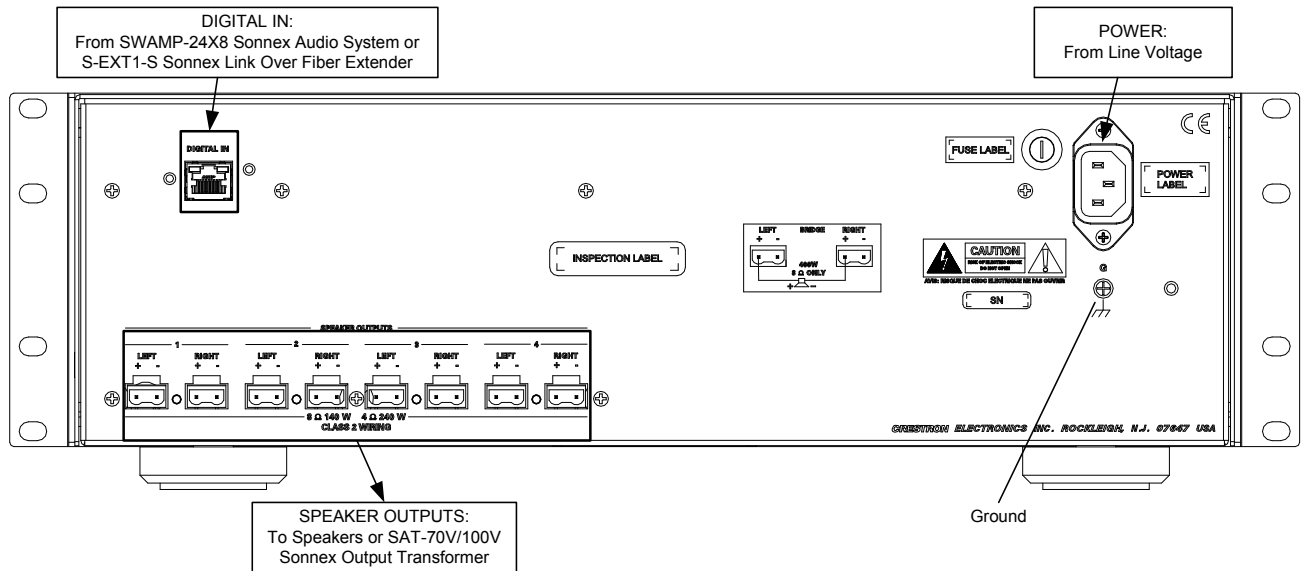

**CAUTION:** Keep the device unplugged until all the input and speaker wiring is complete.

**CAUTION:** Check the speaker wires for shorts and frayed wiring around the **SPEAKER OUTPUTS** connectors.

**NOTE:** Ensure the unit is properly grounded by connecting the chassis ground lug to an earth ground (building steel).

**NOTE:** To prevent overheating, do not operate this product in an area that exceeds the environmental temperature range listed in the table of specifications.

### Speaker Connections

Make speaker connections to the SWAMPE-4 as shown in the following diagram.

#### Speaker Connections

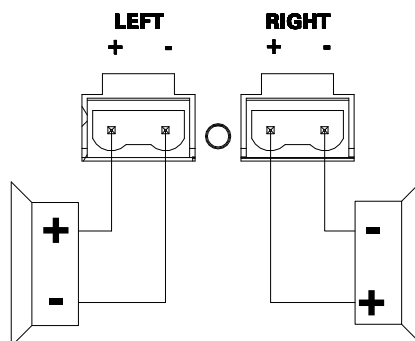



**NOTE:** If the SAT-70V/100V Sonnex Output Transformer is connected to a speaker terminal, use the SAT-70V/100V speaker profile built into the Sonnex Tools application to configure a high-pass filter on the zone that is connected to SAT-70V/100V. For details on speaker profiles, refer to the Sonnex Tools help file.

**Bridge Speaker Outputs (Optional)**

The speaker outputs on the SWAMPE-4 can be bridged to deliver higher power to a speaker. The left channel on an individual output can be bridged with the right channel on the same output. Refer to the following diagram when bridging outputs.

**Bridging Outputs**

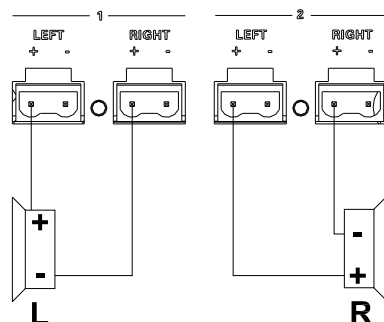

The possible bridging combinations are: Zone 1 + Zone 2 and Zone 3 + Zone 4. LEDs on the back of the SWAMPE-4 indicate bridged outputs.

After the zones are wired for bridged operation, the SWAMPE-4 must be configured with the SWAMP-24X8's *Installer Mode* or with the Sonnex Tools application. Refer to the latest version of the SWAMP(I)-24X8 Sonnex Multiroom Audio System Operations Guide (Doc. 7049) which is available for download from the Crestron Web site ([www.crestron.com/manuals](http://www.crestron.com/manuals)) or the Sonnex Tools help file for more information.

**WARNING:** This device is capable of delivering immense amounts of undistorted power to loudspeakers. Please use caution and adequate ear protection if listening to content at high volume levels as continued exposure to high sound pressure levels can cause permanent hearing impairment or loss.

**Subwoofer Applications (Optional)**

Using a sound level (SPL) meter and Sonnex Tools, outputs on SWAMPE-4 can be used to deliver sound to a left-right stereo pair/subwoofer speaker layout. There are two different wiring configurations that can be used.

**Wiring Diagram: Passive Subwoofer Using an Additional Output Pair**

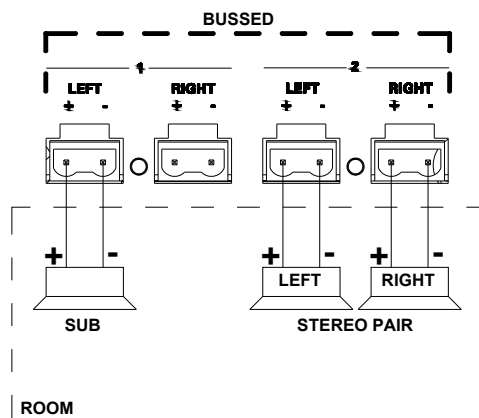

**NOTE:** In this diagram, output 1 and output 2 are used. However, other outputs (either on the SWAMP-24X8 or the SWAMPE-4) can be used.

*Wiring Diagram: Passive Subwoofer Using Bridged Output*

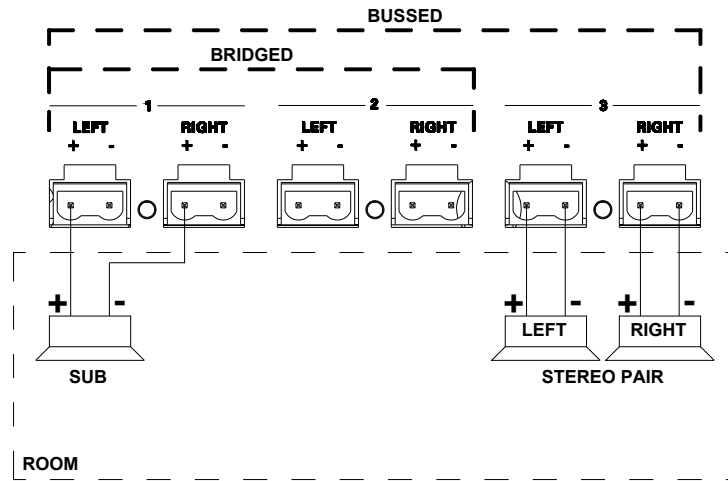

**NOTE:** In this diagram, output 1, output 2, and output 3 are used. However, other outputs (either on the SWAMP-24X8 or the SWAMPE-4) can be used as long as the bridged zones for the subwoofer are adjacent to each other (either on the SWAMP-24X8 or the SWAMPE-4).

1. Connect the speakers and subwoofer as shown in one of the previous diagrams.
2. Refer to the latest version of the SWAMP(I)-24X8 Sonnex Multiroom Audio System Operations Guide (Doc. 7049) for configuration details.

Connect to SWAMP24X8 or S-EXT1-S Sonnex Link Over Fiber Extender

The SWAMPE-4 can be connected to a SWAMP-24X8 or S-EXT1-S Sonnex Link Over Fiber Extender via shielded CAT5 cable.

*SWAMP-24X8 to SWAMPE-4 Connection*

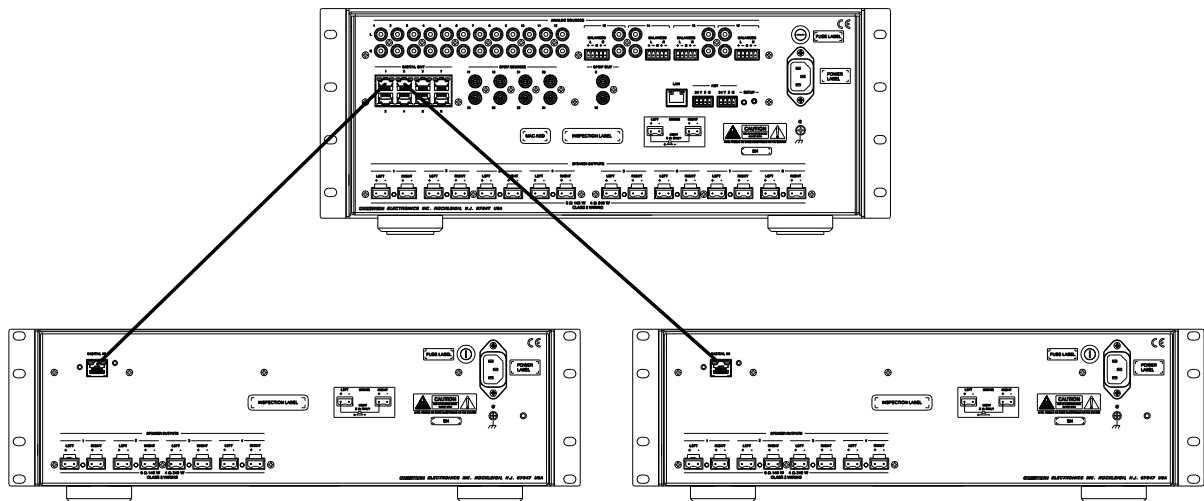

---

**NOTE:** When the SWAMP-24X8 is connected to a control system using Cresnet®, only one Sonnex Link Device can be connected.

**NOTE:** When connecting a SWAMP-24X8 or S-EXT1-S to a SWAMPE-4, Crestron recommends using Crestron DM-CBL-8G or high-quality CAT5e shielded twisted-pair cable. Shielded connectors such as the DM-8G-CONN (sold separately) must be used.

**NOTE:** The maximum cable length between a SWAMP-24X8 or S-EXT1-S and SWAMPE-4 is 200 feet (61 meters).

---

### *Fuse Replacement*

If the SWAMPE-4 does not power up when it is plugged into an AC outlet and the power switch is engaged, the fuse may need to be replaced. The fuse holder is located on the rear panel, above and to the left of the IEC socket assembly. To replace the fuse:

1. Remove AC power.
2. Use a flat head screwdriver to push in the fuse holder.
3. While pushing in the fuse holder, turn screwdriver counterclockwise until the fuse holder pops out.
4. Remove the fuse from the fuse holder and insert a new fuse.

---

**CAUTION:** Only use the specified type of fuse when replacing a blown fuse. Failure to do so may cause damage to the device.

---

SWAMPE-4 MODEL	REQUIRED FUSE TYPE
SWAMPE-4 (US & Canada)	T15AH (1/4" x 1-1/4", 250 V, 15 A, time-lag, high-rupture rated)
SWAMPIE-4 (International/220-240 VAC)	T8AH (5 mm x 20 mm, 250 V, 8 A, time-lag, high-rupture rated)

5. Insert the fuse holder into the device.
6. Push in the fuse holder with a flat head screwdriver. While pushing in the fuse holder, turn the screwdriver clockwise until the fuse holder sinks in.
7. Push in the fuse holder a little further and turn the screwdriver clockwise until the fuse holder locks in place.
8. Connect power to the device.

### *Label the Buttons*

Use Crestron Engraver software to print custom labels for the SWAMPE-4's front panel buttons and LEDs. Crestron recommends printing on 100-pound paper. Paper weighing less than 100 pounds tends to crumple while sliding in, while paper weighing more than 100 pounds may not fit.

## Configuration

The SWAMPE-4 is automatically configured from the front panel of a connected SWAMP-24X8 or by Sonnex Tools software. For more information on configuration options, refer to the latest version of the SWAMP(I)-24X8 Sonnex Multiroom Audio System Operations Guide (Doc. 7049).

---

## Programming Software

---

### Have a question or comment about Crestron software?

Answers to frequently asked questions (FAQs) can be viewed in the Online Help section of the Crestron Web site. To post a question or view questions submitted to Crestron's True Blue Support, log in at [www.crestron.com/onlinehelp](http://www.crestron.com/onlinehelp). First-time users must establish a user account to fully benefit from all available features.

---

### Software Requirements for the PC

---

**NOTE:** The latest software can be downloaded from the Crestron Web site ([www.crestron.com/software](http://www.crestron.com/software)).

---

Crestron provides an assortment of Windows®-based software tools to develop a customized system. Use SystemBuilder™ or SIMPL Windows to create a program to control the SWAMPE-4.

### Programming with SystemBuilder

SystemBuilder is a comprehensive programming environment. Appropriate for most systems, it can quickly and easily generate a complete working program including both control processor logic and touch screen graphics.

### Programming with SIMPL Windows

---

**NOTE:** While SIMPL Windows can be used to program the SWAMPE-4, it is recommended to use SystemBuilder for configuring a system.

---

SIMPL Windows is Crestron's premier software for programming Crestron control systems. It is organized into two separate but equally important "Managers": Configuration and Program.

#### Configuration Manager

Configuration Manager is the view where programmers "build" a Crestron control system by selecting hardware from the *Device Library*.

1. The SWAMP-24X8 must first be incorporated into the system. For instructions, refer to the latest version of the SWAMP(I)-24X8 Sonnex Multiroom Audio System Operations Guide (Doc. 7049).
2. Incorporate the SWAMPE-4 into the system.
  - a. In the *System Views*, right-click on the SWAMP-24X8 device and use the mouse to select **Add item to: "SWAMP-24X8"**.
  - b. Double-click on **SWAMPE-4**. The SWAMPE-4 is added to the system as shown in the following diagram.

The system tree of the control system displays the device in the appropriate slot(s) with a default Net ID or IP ID as shown in the following illustration.

**SWAMP-24X8 Device, Slots 8 and 9**

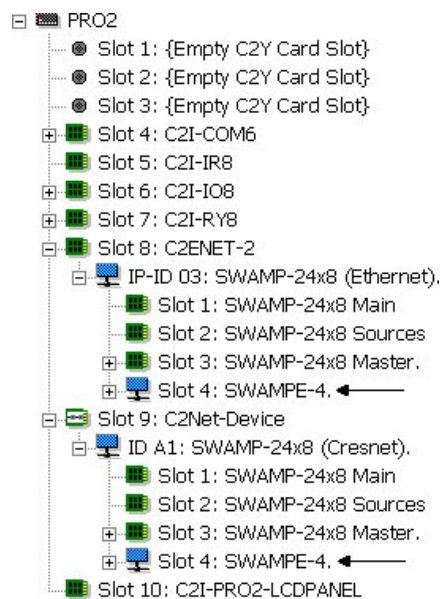

3. Repeat step 2 for each SWAMPE-4 to be added.

---

**NOTE:** If using Cresnet for communications between the SWAMP-24x8 and a control system, only one Sonnex Link Device can be connected.

---

### Program Manager

Program Manager is the view where programmers “program” a Crestron control system by assigning signals to symbols.

The symbol can be viewed by double clicking on the icon or dragging it into *Detail View*. Each signal in the symbol is described in the SIMPL Windows help file (**F1**).

## Uploading and Upgrading

Crestron recommends using the latest programming software and that each device contains the latest firmware to take advantage of the most recently released features. However, before attempting to upload or upgrade it is necessary to establish communication.

### Establishing Communication

All communication with the SWAMPE-4 is managed through the communication link with a connected SWAMP-24X8. For information, refer to the latest version of the SWAMP(I)-24X8 Sonnex Multiroom Audio System Operations Guide (Doc. 7049).

### Programs and Firmware

Any program or firmware updates are managed by the connection with the SWAMP-24X8. For information, refer to the latest version of the SWAMP(I)-24X8 Sonnex Multiroom Audio System Operations Guide (Doc. 7049).



---

## Operation

The SWAMPE-4 operates in either the *Zone* mode or the *Source* mode. The SWAMPE-4's operating mode is determined by the operating mode of the SWAMP-24X8.

For information on operating the SWAMP-24X8, refer to the latest version of the SWAMP(I)-24X8 Sonnex Multiroom Audio System Operations Guide (Doc. 7049).

### Power

Turn on the SWAMPE-4 by moving the On/Off switch to . To turn off the SWAMPE-4, move the On/Off switch to .

### Zone Mode

*Zone* mode uses the SWAMP-24X8's front panel to route a source signal to a selected zone. To enter *Zone* mode:

1. Place the SWAMP-24X8 in *Zone* mode.
2. Press the **ZONE** button of the zone to be controlled.
3. Press the **SOURCE** button of the source to be routed. The associated **SOURCE** and **ZONE** LEDs light.

Alternatively, press the **ZONE** button twice to turn on the zone and connect the last-selected source.

### Source Mode

*Source* mode uses the SWAMP-24X8's front panel to select a source signal and route it to multiple zones. To enter *Source* mode:

1. Place the SWAMP-24X8 in *Source* mode.
2. On the SWAMP-24X8, press the **SOURCE** button of the source to be routed. The associated **SOURCE** LED lights.
3. On the SWAMPE-4, press the **ZONE** buttons of the zones to be selected. The associated **ZONE** LED(s) lights.

To remove a zone from a source, press the desired **ZONE** button. The associated **ZONE** LED turns off.



## Problem Solving

### Troubleshooting

The following table provides corrective action for possible trouble situations. If further assistance is required, please contact a Crestron customer service representative.

#### *SWAMPE-4 Troubleshooting*

TROUBLE	POSSIBLE CAUSE(S)	CORRECTIVE ACTION
Audio dropouts heard on SWAMPE zone.	Bad or no shield on Sonnex cable connecting SWAMP-24X8 and peripheral device.	Ensure continuity and integrity of shield on both ends of the Sonnex cable.
Loss of functionality due to electrostatic discharge.	Improper grounding.	Check that all ground connections have been made properly.
Incorrect audio signal.	Signal is incorrectly routed.	Reroute the signal.
	Zone is incorrectly bussed with other zone(s).	Remove zone from bus.

### Check Wiring

To ensure optimum performance over the full range of the installation topology, use Crestron Certified Wire. Failure to do so may incur additional charges if support is required to identify performance deficiencies because of using improper wire.

### Reference Documents

The latest version of all documents mentioned within the guide can be obtained from the Crestron Web site ([www.crestron.com/manuals](http://www.crestron.com/manuals)).

#### *List of Related Reference Documents*

DOCUMENT TITLE
SWAMP-24X8 Sonnex Multiroom Audio System

### Further Inquiries

To locate specific information or resolve questions after reviewing this guide, contact Crestron's True Blue Support at 1-888-CRESTRON [1-888-273-7876] or refer to the listing of Crestron worldwide offices on the Crestron Web site ([www.crestron.com/offices](http://www.crestron.com/offices)) for assistance within a particular geographic region.

To post a question about Crestron products, log onto the Online Help section of the Crestron Web site ([www.crestron.com/onlinehelp](http://www.crestron.com/onlinehelp)). First-time users must establish a user account to fully benefit from all available features.

## Future Updates

As Crestron improves functions, adds new features and extends the capabilities of the SWAMPE-4, additional information may be made available as manual updates. These updates are solely electronic and serve as intermediary supplements prior to the release of a complete technical documentation revision.

Check the Crestron Web site periodically for manual update availability and its relevance. Updates are identified as an “Addendum” in the Download column.

---

## Return and Warranty Policies

### Merchandise Returns / Repair Service

1. No merchandise may be returned for credit, exchange or service without prior authorization from Crestron. To obtain warranty service for Crestron products, contact an authorized Crestron dealer. Only authorized Crestron dealers may contact the factory and request an RMA (Return Merchandise Authorization) number. Enclose a note specifying the nature of the problem, name and phone number of contact person, RMA number and return address.
2. Products may be returned for credit, exchange or service with a Crestron Return Merchandise Authorization (RMA) number. Authorized returns must be shipped freight prepaid to Crestron, 6 Volvo Drive, Rockleigh, N.J. or its authorized subsidiaries, with RMA number clearly marked on the outside of all cartons. Shipments arriving freight collect or without an RMA number shall be subject to refusal. Crestron reserves the right in its sole and absolute discretion to charge a 15% restocking fee plus shipping costs on any products returned with an RMA.
3. Return freight charges following repair of items under warranty shall be paid by Crestron, shipping by standard ground carrier. In the event repairs are found to be non-warranty, return freight costs shall be paid by the purchaser.

### Crestron Limited Warranty

Crestron Electronics, Inc. warrants its products to be free from manufacturing defects in materials and workmanship under normal use for a period of three (3) years from the date of purchase from Crestron, with the following exceptions: disk drives and any other moving or rotating mechanical parts, pan/tilt heads and power supplies are covered for a period of one (1) year; touch screen display and overlay components are covered for 90 days; batteries and incandescent lamps are not covered.

This warranty extends to products purchased directly from Crestron or an authorized Crestron dealer. Purchasers should inquire of the dealer regarding the nature and extent of the dealer's warranty, if any.

Crestron shall not be liable to honor the terms of this warranty if the product has been used in any application other than that for which it was intended or if it has been subjected to misuse, accidental damage, modification or improper installation procedures. Furthermore, this warranty does not cover any product that has had the serial number altered, defaced or removed.

This warranty shall be the sole and exclusive remedy to the original purchaser. In no event shall Crestron be liable for incidental or consequential damages of any kind (property or economic damages inclusive) arising from the sale or use of this equipment. Crestron is not liable for any claim made by a third party or made by the purchaser for a third party.

Crestron shall, at its option, repair or replace any product found defective, without charge for parts or labor. Repaired or replaced equipment and parts supplied under this warranty shall be covered only by the unexpired portion of the warranty.

Except as expressly set forth in this warranty, Crestron makes no other warranties, expressed or implied, nor authorizes any other party to offer any warranty, including any implied warranties of merchantability or fitness for a particular purpose. Any implied warranties that may be imposed by law are limited to the terms of this limited warranty. This warranty statement supersedes all previous warranties.



**Crestron Electronics, Inc.**  
15 Volvo Drive Rockleigh, NJ 07647  
Tel: 888.CRESTRON  
Fax: 201.767.7576  
[www.crestron.com](http://www.crestron.com)

---

**Operations Guide – DOC. 7221B**  
**(2031152)**  
**08.12**  
Specifications subject to  
change without notice.